

**EL LÍDER EN TECNOLOGÍA**  
THE LEADER IN TECHNOLOGY

**EL LÍDER EN CALIDAD**  
THE LEADER IN QUALITY

**EL LÍDER EN COMPROMISO  
MEDIOAMBIENTAL**  
THE LEADER IN THE  
COMMITMENT TO THE  
ENVIRONMENT

**EL LÍDER EN SERVICIO**  
THE LEADER IN SERVICE

# **CAT.ESPECIALISTA** **SPECIALIST GUIDE**



**4 Advertencia Legal**

Mezu Legala  
Legal Warning  
Informations Légales  
Rechtliche Hinweise

**5-9 Índice**

Aurkibidea  
Index  
Index  
Gesamtverzeichnis

**A1-A31 MÁQUINAS PARA LLAVES DE SEGURIDAD**  
SEGURTASUN-GILTZETARAKO MAKINAK  
MACHINES FOR SECURITY KEYS  
MACHINES POUR CLES DE SECURITE  
MASCHINEN FÜR SICHERHEITSSCHLÜSSEL**A1-A7 Máquinas**

Makinak  
Machines  
Machines  
Maschinen

**A8 Simbología**

Sinbologia  
Symbols  
Symbolique  
Symbologie

**A9-A28 Ficha Especialista**

Giltzen fitxa teknikoa  
Technical file keys  
Fiche technique clés  
Technisches Datenblatt Schlüssel

**A29-A31 Llaves Originales**

Jatorrizko giltzak  
Original keys  
Clé originales  
Originalschlüssel

**B1-B16 MÁQUINAS PARA LLAVES PLANAS**  
GILTZA LAUETARAKO MAKINAK  
MACHINES FOR FLAT KEYS  
MACHINES POUR CLE PLATES  
MASCHINEN FÜR PLANE SCHLÜSSEL**B1-B7 Máquinas**

Makinak  
Machines  
Machines  
Maschinen

**B8 Simbología**

Sinbologia  
Symbols  
Symbolique  
Symbologie

**B9-B14 Ficha Especialista**

Giltzen fitxa teknikoa  
Technical file keys  
Fiche technique clés  
Technisches Datenblatt Schlüssel

**B15-B16 Llaves Originales**

Jatorrizko giltzak  
Original keys  
Clé originales  
Originalschlüssel

**C1-C9 MÁQUINAS PARA LLAVES DE GORJA**  
GORJA-GILTZETARAKO MAKINAK  
MACHINES FOR BIT KEYS  
MACHINES POUR CLES A GORGES  
MASCHINEN FÜR DOPPELBARTSCHLÜSSEL**C1-C5 Máquinas**

Makinak  
Machines  
Machines  
Maschinen

**C6 Simbología**

Sinbologia  
Symbols  
Symbolique  
Symbologie

**C7-C9 Ficha Especialista**

Giltzen fitxa teknikoa  
Technical file keys  
Fiche technique clés  
Technisches Datenblatt Schlüssel

### ESPAÑOL

#### AVISO LEGAL

Las llaves que aparecen en este catálogo son piezas JMA fabricadas por JMA Alejandro Altuna S.L.U. o un subcontratista de éste. Están diseñadas para cilindros y cerraduras de los fabricantes cuyas marcas se indican en este catálogo.

Conforme a las disposiciones legales vigentes relativas a la propiedad industrial, las marcas o nombres comerciales indicados en este catálogo son propiedad exclusiva de los fabricantes de cilindros y cerraduras, así como de los fabricantes de automóviles, otros constructores, distribuidores y usuarios.

Dichas marcas o nombres comerciales se indican en calidad simplemente informativa con el fin de reco-

nocer con rapidez la cerradura a la que corresponden nuestras piezas.

Este catálogo está reservado exclusivamente a profesionales de la reproducción de llaves que utilizan piezas JMA.

Los datos referentes a los productos de este catálogo tienen carácter indicativo. Manteniendo siempre las características básicas, nos reservamos el derecho de realizar, sin previo aviso, modificaciones técnicas, estéticas o de otro tipo, por razones de evolución de los productos en cuestión.

Algunos modelos que están en este nuevo catálogo podrán recibirlos tanto con la marca y la referencia JMA como con otra marca del grupo ALTUNA.

### EUSKERA

#### LEGE-OHARRA

Katalogo honetan ageri diren giltzak JMA Alejandro Altuna S.L.U.enpresak edo honekkontratatuakobeste enpresabatek egindako JMA piezak dira. Katalogoan zehazten diren marken fabrikatzaileen zilindro eta sarrailetarako diseinatuta daude.

Jabetza industrialari buruz indarrean dauden lege-xedape-nekin bat etorri, katalogo honetan zehaztutako merkataritza-markak edo izenak zilindro eta sarraileen fabrikatzaileen nahiz ibilgailuen fabrikatzaileen eta beste erakitzailen, banatzaile eta erabiltzaile batzuen jabetza eskusibokoak dira.

Merkataritza-marka edo izen horiek zehaztasun gehiago emateko adierazten dira, gure piezak zein sarraileri dagozkion berehala ikusi ahal izateko.

Katalogo hau giltzen kopia egiteko JMA piezak erabiltzen dituzten profesionalentzako da soilik.

Katalogo honetako produktuei buruzko datuek izaera adierazgarria dute. Oinarriko ezaugarriak gordez, produktuen bilakaeraren ondoriozko aldaketa teknikoak, estetikoak edo bestelakoak egiteko eskubidea dugu, aurretik horren berri eman beharrik gabe.

Katalogo berri honetan dauden eredu eta batzuk JMA marka eta erreferentziarekin nahiz ALTUNA taldeko beste marka batekin jaso ahal izango dira.

### ENGLISH

#### LEGAL WARNING

The keys that appear in this catalogue are JMA parts manufactured by JMA Alejandro Altuna S.L.U. or one of its subcontractors. They are designed for cylinders and locks made by the manufacturers whose trademarks are indicated in this catalogue.

In accordance with legal requirements relating to industrial property rights, the trademarks or trade names indicated in this catalogue are the exclusive property of the manufacturers of the cylinders and locks, as well as automobile manufacturers, other constructors, distributors and users.

The aforementioned trademarks or trade names are indicated simply for information purposes so that the lock to which our parts correspond can be recognised quickly and easily. This catalogue is for the exclusive use of professional key copiers who use JMA parts.

Data referring to the products in this catalogue are indicative in nature. Although the basic characteristics are maintained at all times, we reserve the right to make, without previous notice, any technical, aesthetic or other types of changes involved in the development of the products in question. Some of the keys in this new catalogue could be received either with the JMA reference and trademark or with another trademark from the ALTUNA group.

### FRANÇAIS

#### MENTIONS LEGALES

Les ébauches de clés reportées sur ce catalogue sont des ébauches JMA fabriquées par JMA Alejandro Altuna S.L.U. ou un de ses sous-traitants. Elles sont destinées aux cylindres et serrures des fabricants dont les marques sont indiquées dans ce catalogue.

Conformément aux dispositions légales en vigueur relatives à la propriété industrielle, les marques ou les dénominations commerciales citées dans ce catalogue sont la propriété exclusive des fabricants de cylindres et de serrures ainsi que des constructeurs de voitures, autres constructeurs, distributeurs et utilisateurs.

Ces marques ou dénominations commerciales sont indiquées à titre de simple information afin de connaître rapidement à quelle serrure nos ébauches sont destinées.

Ce catalogue est exclusivement réservé aux professionnels de la reproduction de clés, utilisant des ébauches JMA.

Les renseignements sur les produits de ce catalogue sont donnés à titre indicatif. Tout en gardant les caractéristiques de base, nous nous réservons le droit d'apporter, sans préavis, des modifications techniques, esthétiques ou autres, dues à l'évolution des produits en question.

Des ébauches de ce catalogue pourront être livrées soit avec la marque et référence JMA soit avec une autre marque du groupe ALTUNA.

### DEUTSCH

#### IMPRESSUM

Die in dem vorliegenden Katalog aufgeführten Schlüssel sind JMA-Teile, die von der Firma JMA Alejandro ALTUNA, S.L.U. einem Zulieferanten von JMA, hergestellt werden. Sie sind für Zylinder und Schlösser derjenigen Hersteller entwickelt worden, deren Marken in diesem Katalog aufgeführt sind.

In Übereinstimmung mit den geltenden gesetzlichen Vorschriften bezüglich des gewerblichen Eigentums sind die im vorliegenden Katalog aufgeführten Marken und Firmennamen ausschließliches Eigentum der Zylinder- und Schloßhersteller, sowie der Automobilhersteller und anderer Konstrukteure, Vertrieber und Benutzer.

Diese Marken und Firmennamen werden nur zu Informationszwecken aufgeführt, mit dem Ziel, auf schnelle Weise zu erkennen, zu welchem Schloß unsere Teile gehören.

Dieser Katalog ist ausschließlich für Fachleute des Bereichs der Schlüsselreproduktion gedacht, die JMA-Teile verwenden.

Die Daten bezüglich der Produkte des vorliegenden Katalogs haben informativen Charakter. Bei Aufrechterhaltung der grundlegenden Eigenschaften behalten wir uns das Recht vor, aus Gründen der Entwicklung der entsprechenden Produkte und ohne Vorankündigung technische, ästhetische oder andere Änderungen vorzunehmen. Einige Modelle des neuen Katalogs können Sie sowohl mit der Marke und der Bezeichnung JMA erhalten, als auch mit jeder anderen Marke der Gruppe ALTUNA.



**THE KEY TO EXCELLENCE**  
GLOBALLY UNLOCKING MILLIONS OF DOORS DAILY



# ÍNDICE

AURKIBIDEA

INDEX

INDEX

GESAMTVERZEICHNIS



**THE KEY TO EXCELLENCE**  
GLOBALLY UNLOCKING MILLIONS OF DOORS DAILY

REF.	PAG.
26-M	C9
7-S	C9
AB-1T	A10
AB-2T	A10
AB-3T	A10
AB-4T	A10
ABC-6	A10
ABC-7	A10
ABL-1	B10 C8
ABL-2	B10 C8
ABL-3	B10 C8
ABL-4	B10 C8
ABU-16	A10
ABU-29P	B10 C8
ABU-3	C8
ABU-34	A10
ABU-61	A10
ABU-63	A10
ABU-66	A10
ABU-81	A10
ADPLE-11	C8
ADPLE-22	C8
ADPLE-33	C8
ADPLE-44	C8
ADPLE-55	C8
AGA-12	A10
AGA-1T	A10
AGA-25	A10
AGA-29	A10
AGA-2T	A10
AGA-38	A10
AGA-39	A10
AGA-42	A10
AGA-43	A10
AGA-44	A10
AGA-48	A10
AGA-49	A10
AGA-50	A10
AGB-2	A11
AGB-4	A11
AGB-5	A11
ALA-1X	B10
AMG-10	A11
AMG-10D	A11
AMG-8D	A11
AMG-9D	A11
ANC-2	C8
AP-1D	A11
AP-3D	A11
AP-4D	A11
AP-5D	A11
ARC-17DP	C8
ARC-17P	C8
ARFE-2	C8
AX-2P	A11
AZ-12	A11
AZ-14	A11
AZ-17D	B10
AZ-1D	B10

REF.	PAG.
AZ-11	B10
AZ-29	A11
AZ-32	A11
AZ-7	A11
AZ-8D	A11
AZ-8D	A11
AZ-9	A11
AZ-9D	A11
BA-1D	B10
BAG-1	A11
BAI-8D	A11
BAI-9D	A12
BDA-1	A11
BEY-1D	A12
BEY-2D	A12
BL-1T	A12
BKY-1	A12
BKY-2	A12
BLU-1X	B10
BM-1P	A17
BM-4	A17
BM-5P	A17
BM-6P	A17
BM-7P	A17
BRAS-1	A12
BRI-10	B10
BRI-12	B10
BRI-16	A12
BRI-25	A12
BRI-26	A12
BRI-27	A12
BRI-28	A12
BRI-29	A12
BRI-30	A12
BRI-31	A12
BRI-33	A12
BRI-34	A12
BRI-34	A12
BRI-3X	B10
BUL-1	A12
BUR-33	A12
BUR-4X	B10
BUR-5X	B10
BYP-1D	A12
CARAT P3	A27
CAY-2	A12
CE-114	A12
CHI-1T	A13
CHU-10	A13
CI-14	A13
CI-17	A13
CI-21	A13
CI-25	A13
CI-26	A13
CI-30	A13
CI-31	A13
CI-32	A13
CI-33	A13
CI-35	A13
CI-48	A13

REF.	PAG.
CI-56	A13
CI-57	A13
CI-59	A13
CI-60	A13
CI-66	A13
CI-71	A13
CI-72	A13
CI-73	A13
CIT-1P	A27
COR-37	A13
COR-77	A13
CVL-9D	A14
DAF-2	A14
DAF-3D	A14
DAF-4D	A14
DEK-11	A14
DEK-3	A14
DEK-4	A14
DEK-8	A14
DEN-1	C8
DEN-2	C8
DIE-1	C8
DLC-1	A14
DLC-2	A14
DLC-3	A14
DO-3	A15
DO-4	A15
DOM-17I	A14
DOM-22	A14
DOM-30	A14
DOM-31	A14
DOM-32	A14
DOM-33	A14
DOM-34	A14
DOM-39	A14
DOM-43	A14
DOM-56D	A14
DOM-63D	A14
DOM-B1	A15
DOM-B6	A15
DR-1	A14
ELZ-10	A15
ELZ-10D	A15
EU-12	A15
EZ-DS10	A15
EZ-DS10E	A15
EZ-DS15	A15
EZ-DS15R	A15
F-B-10	B11
F-B-11	B11
F-B-12	B11
F-B-13	B11
F-B-14	B11
F-B-15	B11
F-B-16	B11
F-B-17	B11
F-B-17	B11
F-B-18	B11
F-B-26	B12

REF.	PAG.
F-B-27	B12
F-B-28	B12
F-B-29	B12
F-B-2D	B11
F-B-2I	B11
F-B-30	B12
F-B-32	B12
F-B-4	B11
F-B-5	B11
F-B-6	B11
F-B-7	B11
F-B-8	B11
F-B-9	B11
FAC-19	A15
FAC-23	A15
FAC-24	A15
FAV-1D	A15
FAV-2	A15
FAY-1D	A16
FF-13	A16
FI-16P	A26
FIC-18	A16
FIC-2	A16
FIC-3	A16
FIC-4	A16
FM-1X	B12
FO-22P	C8
FO-24P	A16
FO-4P	C8
FO-6P	A16 B12 C8
FON-1E	A16
FON-2E	A16
FON-3E	A16
FON-5E	A16
FON-6E	A16
FTH-16	A16
FTH-23	A16
FTH-24	A16
FTH-25	A16
FTH-26D	A16
FTH-29	A16
FTH-30	A16
FTH-7	A16
FV-3	A16
GDA-1P	A16
GE-2 Pextra Flex	B12
GIOB-3P	A16
GM-49DP	A16
GOD-1	A16
GOD-2	A16
HB-1	A17
HEC-1	C8
HOND-17P	A17
HOND-31P	A17
HTE-50	A17
HU-2P	A17
HU-2P-1	A17
HU-DHP	A17
HU-DHP-1	A17

# ÍNDICE GENERAL GENERAL INDEX

REF.	PAG.
HU-DHP-3	A17
HU-DHP2	A17
HU-DNP	A17
HU-HAAP	A17
HU-HAAP1	A17
HU-HCAP	A17
HY-18P	A18
HY-18P1C1	A18
HY-19P	A18
IF-2	A18
IF-3P	C9
IF-4	A18
IF-6	A18
INCE-1E	A18
IR-1P	A18
IS-10	A18
IS-10P	A18
IS-14D	A18
IS-20	A19
IS-6D	A19
ITO-2D	A19
JAR-1E	A19
JAU-1P	A25 C9
JAU-2P	A25 C9
JIS-4P	A19
JPM-1E	A19
JPM-2E	A19
KA-1	A19
KA-10	A19
KA-11	A19
KA-2	A19
KA-3	A19
KA-4	A19
KA-5	A19
KA-6	A19
KA-7	A19
KA-8	A19
KAE-1	A19
KAE-10D	A19
KAE-11D	A20
KAE-12D	A20
KAE-14	A20
KAE-2	A19
KAE-4	A19
KE-1	A20
KE-3	A20
KE-4	A20
KE-5	A20
KI-7P	A19
KI-9P	A19
LAP-10D	A20
LAP-11D	A20
LAP-13P	A20
LAP-17P	A20
LAP-1E	A20
LAP-20P	A20
LAP-21P	A20
LAP-22P	A20
LAP-23P	A20

REF.	PAG.
LAP-2E	A20
LAP-4	A20
LAP-8D	A20
LIN-13	A20
LIN-19D	A21
LIN-21D	A21
LIN-26D	A21
LYF-1T	A21
LYF-2T	A21
MAS-15P	A21
MASL-1	A21
MAZ-12P1	A21
MCM-10	A21
MCM-13D	B12
MCM-16	A21
MCM-18D	B12
MCM-21D	A21
MCM-27	A21
MCM-30	B12
MCM-4SS	A21
ME-10P	A17
ME-11P	A17
ME-12P	A17
ME-2P	A18
ME-3P	A18
ME-4P	A18
ME-5P	A18
ME-6P	A18
ME-7P	A18
ME-8P	A18
MER-1T	A21
MER-3T	A21
MGA-2	A21
MIL-1	C9
MIL-2	C9
MILES	C9
MIW-2	B12
MIW-3	B13
MIW-4	B13
MLM-4	A21
MSM-1	A21
MSV-1	B13
MSV-2	B13
MUL-T10P	A22
MUL-T11P-1	A22
MUL-T16P	A22
MUL-T16P	A22
MUL-T2P	A21
MUL-T2P	A21
MUL-T3P1	A21
MUL-T3PL	A22
MUL-T4P	A22
MUL-T5P	A22
MUL-T7P	A22
MUL-T8P-1	A22
MUL-T9P-1	A22
NE-40	A22
NE-40P-1	A22
NE-41P	A22

REF.	PAG.
NE-51P2	A22
OJ-Q	A22
OMC-3	A23
OMC-4	A23
OMC-7	A23
OP-11C1	A18
OP-11P1	A18
OP-WHC	A18
OP-WHP	A18
OP-WVYP	A18
ORIGINAL	A23
BRAVUS	
ORIGINAL C-2/C-3/C-4	A21
ORIGINAL C-5	A21
ORIGINAL CS7 / CSP-7 / CS8	A24
ORIGINAL CX6	A12
ORIGINAL D12	B10
ORIGINAL DUAL XP	A12
ORIGINAL	A14
EUROVAL	
ORIGINAL GERA WS / WS XP / PLUS	A16
ORIGINAL INTE-RACTIVE L / R	A22
ORIGINAL IX DAS 138	A15
ORIGINAL IX5 DAS 038	A15
ORIGINAL IX6 KG 102/121	A15
ORIGINAL IX6 SR 132/232	A15
ORIGINAL MT5	A22
ORIGINAL NW4	A21
ORIGINAL RS8	B10
ORIGINAL ST15	A24
ORIGINAL ST6	A24
ORIGINAL ST8	A24
ORIGINAL VRX	A27
ORIGINAL WS 50 NW	A12
ORIGINAL WS 50 RA, RK, RZ	A12
ORIGINAL WSM	A12
ORIGINAL X-TRA	A27
ORIGINAL XP/SP	B10
PC-1T	A23
PC-3TP	A23
PCI-1T	A23
PEN-2	A23
PEN-2	C9
PEU-1C-1	A27
PEU-1P	A27
PEU-2C-1	A27
PFA-13D	A23
PFA-14D	A23
PFA-15D	A23

REF.	PAG.
PFA-16D	A23
PIC-1E	A23
PIC-8D	A23
PO-1P	B12
PO-2P	B12
POL-3TEC	A23
POL-4E	A23
POL-5TEC	A23
PTN-1D	A23
PTN-2D	A23
ROSE-1	A23
RU-11D	B13
RU-12D	B13
RU-14D	B13
RU-5D	B13
RU-5I	B13
RU-6I	B13
RU-9D	B13
RU-9I	B13
SAA-1P1	A23
SAG-1T	A25
SAG-1T	A26
SCR-1	A24
SEA-1	A23
SEA-2	A23
SEC-1	A23
SEC-2	A23
SEC-3	A24
SER-1T	A24
SER-3D	A24
SID-1	A24
SID-2	A24
SIP-4P3	A26
SIP-4P4	A26
SIX-3P	B13
SIX-3P	B13
SMR-1P	A24
SOF-1	B13
SOF-2	B14
SOL-1	C9
SPI-1	A24
SPI-1D	A24
STS-35	A24
STS-36	A24
STS-36	A24
STS-37	A24
STS-38	A24
STS-B1	A24
STS-T14	A24
STS-TV3	A24
STS-TV5	A24
STS-TV8	A24
STS-TV9	A24
STS-X5	A24
STS-X6	A24
SUB-2P	A24
TC-1	A25
TE-23	B14
TE-28	B14

REF.	PAG.
TE-8I	B14
TE-T10	A25
TE-T10D	A25
TE-T11	A25
TE-T12PLUS	A25
TE-T60	A25
TE-T61	A25
TE-T62	A25
TE-T80	A25
TE-T80EH	A25
TE-T80SC	A25
TE-T82	A25
TEC-2	A25
TIT-6	A25
TKY-2	A26
TOV-2	A25
TOV-4	A25
TOV-5	A25

REF.	PAG.
TOV-6	A25
TOV-7	A26
TOYO-18P	A26
TOYO-30P	A26
TOYO-30P	A26
TOYO-30P1	A26
TOYO-36P	A26
TP00	A17
TRL-4P	A26
TRO-1	A25
TRO-1D	A25
TRU-7	C9
TRU-8P	C9
TX-2	A26
UCEM-13D	A26
UCEM-17D	A26
UCEM-5D	A26
UCEM-5I	A26

REF.	PAG.
UCEM-8D	A26
UCEM-8DP	A26
URB-3D	A26
URB-4D	A26
URKO-4	C9
VA-11	A26
VA-15	A26
VA-17P	A26
VA-25	A26
VA-25	A26
VA-26	A26
VA-27	A27
VA-28	A27
VA-56	A27
VA-58	A27
VA-70	A27
VI-14	A27
WAN-1D	A27

REF.	PAG.
WIL-22	A27
WIN-1D	A27
WIN-1I	A27
WIN-2D	A27
WIN-3D	A27
WIN-4D	A27
WT-1	A27
YA-23	A27
YA-280D	A27
YA-30	C9
YA-81	A27
YAR-1	A27
YAR-2	A28
YAR-3	A28
ZA-10	A28
ZA-14P	A28



## ÍNDICE DE MARCAS

MARKEN AURKIBIDEA • BRAND INDEX • INDEX MARQUE • HAUPTMARKE

MARCA- MARKA- MAIN MARQUE - MARKE	PÁG.
ABC	A10
ABLOY	A10, B10, C8
ABSA	A10
ABUS	A10, B10, C8
ADPLE	C8
AGA	A10, A11
AGB	A11
ALA	B10
AMIG	A11
ANCHOR	C8
APEX	A11
ARCU	C8
ARFE	C8
ASSA / RUKO / TRIO-VING	B10
AXA	A11
AZBE	A11, B10
BAGEM	A11
BAODEAN	A11
BASI	A11, A12, B10
BEY	A12
BILMA	A12
BKS	A12
BLUMA	B10
BORKEY	A12
BRAS	A12
BRICARD	A12, B10
BULAT	A12
BURG	A12, B10
BYP	A12
CAYS	A12
CES	A12, A13
CHICAGO	A13
CHUBB	A13
CISA	A13
CORBIN	A13, A14
CVL	A13, A14
DAF	A15
DEKABA	A15
DEKABA	A15
DELCA	A15
DENNY	C8
DIEBOLD	C8
DIERRE	A15
DOM	A15, B10, B11
DOMUS	A15
ELZETT	A15
EUROLOCKS	A15
EZCURRA	A15
F-CV	A15
FAB	B11, B12
FAC	A15
FAVOUR	A15, A16
FAYN	A16

MARCA- MARKA- MAIN MARQUE - MARKE	PÁG.
FF	A16
FIAM	B12
FICHET	A16
FONTAINE	A16
FORD	A16
FORD	B12
FORD	C8
FTH	A16
G.M.	A16
GE GE	B12
GERA	A16
GERDA	A16
GIOBERT	A16
GODREJ	A16
HB	A17
HECTOR	C8, C9
HONDA	A17
HTEC	A17
HUF	A17, A18, B12
HYUNDAI	A18
IFAM	A18, C9
INCECA	A18
IR	A18
ISEO	A18, A19
ITO	A19
JARDI	A19
JIS	A19
JPM	A19
KABA	A19
KALE	A19, A20
KESO	A20
KIA	A20
LAPERCHE	A20
LINCE	A20
LINCE	A20, A21
LYF	A21
MASTER	A21
MASTER LOCK	A21
MAUER	A21
MAZDA	A21
MCM	A21, B12
MERONI	A21
MG MONTI	A21
MILES	C9
MIWA	B12, B13
MLM	A21
MSM	A21
MSV	B13
MUL.T.LOCK	A21, A22
NEIMAN	A22
OJMAR	A22, A23
OMECA	A23
P.C.	A23

MARCA- MARKA- MAIN MARQUE - MARKE	PÁG.
P&C I.	A23
PENZMASH	A23, C9
PFÄFFENHAIN	A23
PICARD	A23
POLLUX	A23
POTENT	A23
RIL	C9
ROSSETTI	A23
RUKO	B13
SAAB	A23
SEA	A23
SECUREMME	A23, A24
SECURITAL	A24
SERRALLER	A24
SERRETA	C9
SIDESE	A24
SIMPLEX	B13
SMART	A24
SOFER	B13, B14
SOLER	C9
SPIDER	A24
STS	A24
SUBARU	A24
T-KEY	A25
TARONI	A25
TECON	A25
TECSESA	A25
TESA	A25, B14
TIBBE	A25
TIBBE	C9
TITAN	A25
TOVER	A25, A26
TOYOTA	A26
TRELOCK	A26
TRUPER	C9
TRW-SIPEA	A26
TSAG	A26
TSAG	A26
UCEM	A26
UNIVERSAL	A26
URBIS	A26
URKO	C9
VACHETTE	A26, A27
VALEO	A27
VIRO	A27
WANJIN	A27
WILKA	A27
WINKHAUS	A27
WT	A27
YALE	A27, C9
YARDENI	A27, A28
ZADI	A28



# **MÁQUINAS MECÁNICAS**

MAKINA MEKANIKOAK  
MECHANICAL MACHINES  
MACHINES MECANIQUES  
MECHANISCHE MASCHINEN



***CAPRI - CAPRI S. - NEO - DAKKI - XCODE***

## ***PARA LLAVES DE SEGURIDAD***

*SEGURITATEZKO GILTZENTZAT  
FOR SECURITY KEYS  
POUR CLES DE SECURITE  
FÜR SICHERHEITSSCHLÜSSEL*

***THE KEY TO EXCELLENCE***  
*GLOBALLY UNLOCKING MILLIONS OF DOORS DAILY*



## MÁQUINAS MACHINES



### CAPRI

*CAPRI es la máquina duplicadora de JMA para llaves de seguridad, regata, tubulares y especiales. Con la máquina duplicadora CAPRI damos un salto cualitativo sobre el resto de máquinas duplicadoras manuales del mercado, al incorporar un novedoso sistema patentado de medición de la fuerza o presión en el duplicado, haciendo que el trabajo de copia sea una tarea sencilla y precisa.*

*CAPRI is JMA duplicating machine for security, channel, tubular and special keys. With the CAPRI duplicating machine we make a qualitative jump over the rest of manual duplicating machines on the market, by incorporating an innovative patented system for measuring the strength or pressure in the duplication, making the copy task easy and precise.*



### CAPRI SMART

*CAPRI-SMART es la máquina duplicadora de JMA para llaves de seguridad, regata y especiales, diseñada para los profesionales de la duplicación. Una versión sencilla de la máquina duplicadora más avanzada del mercado CAPRI. La robustez de su diseño, las nuevas tecnologías incorporadas y materiales de última generación utilizados, hacen de ella una duplicadora duradera que mantiene siempre su precisión de duplicado.*

*CAPRI-SMART is the JMA duplicating machine for security, channel and special keys, designed by professionals from the duplicating world. A simple version of the most advanced duplicating machine of the market, the CAPRI. The strength of its design, the new technologies and last generation materials, make this a long-lasting duplicator that always maintains precision of duplication.*



## NEO

*Neo es la máquina en la que se combinan la precisión y la sencillez a la hora de duplicar las llaves de seguridad, regata y especiales. Reúne nuevas prestaciones como la iluminación Led y la pantalla protectora en la zona de trabajo. Novedosa mordaza donde se han incluido el amarre de llaves de seguridad y llaves de automoción de regata de corte láser sin necesidad de adaptador.*

*Neo is the machine that combines precision and simplicity to duplicate security, channel and special keys. It includes new features like Led illumination and a protective screen in the work area. This machine is the first in its category to incorporate a new clamp where the clamping of security keys, and laser cut automotive channel keys has been incorporated without the need of an adaptor (VAG ® keys group fixing area and another for Mercedes® keys).*



## DAKKI

*DAKKI es la máquina duplicadora de JMA para llaves de seguridad, regata de automoción y especiales. Sencilla en su concepción pero precisa en su uso, hacen de ella una máquina económica para el duplicado de llaves de seguridad. Máquina compacta y de diseño de líneas limpias, hacen de ella una duplicadora robusta y de uso ergonómico.*

*DAKKI is JMA duplicating machine for security, automation channel and special keys. Simple conception but precise in use, make this an economic machine for duplicating security keys. A compact machine with clean lines, makes this machine a strong duplicator and ergonomic in use.*



## X-CODE

*La X-Code es una máquina duplicadora de llaves a código especiales, seguridad y automóvil, controlada electrónicamente. Su funcionamiento puede ser de forma autónoma o mediante la conexión a un PC.*

*The X-Code is a duplicating machine for special code, security and automobile keys with electronic control. It can operate independently or by connection to a PC.*





## FRESAS CUTTERS

CODE	A	B	C	D	E	PARA-FOR	MAT
F-1	90	0,8		45	6	Capri - Capri S. - Neo -Dakki - Xcode	HSS
F-1A	90	0,8		45	8	Capri - Capri S. - Neo -Dakki - Xcode	HSS
F-1W	90	0,8		45	6	Capri - Capri S. - Neo -Dakki - Xcode	W
F-3			1,5	45	6	Capri - Capri S. - Neo -Dakki - Xcode	HSS
F-3W			1,5	45	6	Capri - Capri S. - Neo -Dakki - Xcode	W
F-4	90	0,4		45	6	Capri - Capri S. - Neo -Dakki - Xcode	HSS
F-5	90	0,9		45	6	Capri - Capri S. - Neo -Dakki - Xcode	HSS
F-5W	90	0,9		45	6	Capri - Capri S. - Neo -Dakki - Xcode	W
F-6	106	1		45	6	Capri - Capri S. - Neo -Dakki - Xcode	HSS
F-7	90	0,7	4	45	6	Capri - Capri S. - Neo -Dakki - Xcode	HSS
F-8			4	45	6	Capri - Capri S. - Neo -Dakki - Xcode	HSS
F-8W			4	45	6	Capri - Capri S. - Neo -Dakki - Xcode	HSS
F-9			5,95	40	6	Capri - Capri S. - Neo -Dakki - Xcode	HSS
F-9W			5,95	40	6	Capri - Capri S. - Neo -Dakki - Xcode	W
F-11			2,5	45	6	Capri - Capri S. - Neo -Dakki - Xcode	HSS
F-11W			2,5	45	6	Capri - Capri S. - Neo -Dakki - Xcode	W
F-12A	100	0,6		45	6	Capri - Capri S. - Neo -Dakki - Xcode	HSS
F-12B	100-90	2,1-2,9		45	6	Capri - Capri S. - Neo -Dakki - Xcode	HSS
F-13	100	0,8		45	6	Capri - Capri S. - Neo -Dakki - Xcode	HSS
F-13W	100	0,8		45	6	Capri - Capri S. - Neo -Dakki - Xcode	W
F-14	100	1,45		45	6	Capri - Capri S. - Neo -Dakki - Xcode	HSS
F-15		2	5	45	6	Capri - Capri S. - Neo -Dakki - Xcode	HSS
F-16	130	0,6		45	6	Capri - Capri S. - Neo -Dakki - Xcode	HSS
F-17			3	45	6	Capri - Capri S. - Neo -Dakki - Xcode	HSS
F-17W			3	45	6	Capri - Capri S. - Neo -Dakki - Xcode	W
F-19	90	1,2		45	6	Capri - Capri S. - Neo -Dakki - Xcode	HSS
F-19W	90	1,2		45	6	Capri - Capri S. - Neo -Dakki - Xcode	W
F-21	85	0,72		45	6	Capri - Capri S. - Neo -Dakki - Xcode	HSS
F-22			2,4	40	6	Capri - Capri S. - Neo -Dakki - Xcode	HSS
F-23	90	0,8	3,3	45	6	Capri - Capri S. - Neo -Dakki - Xcode	HSS

CODE	A	B	C	D	E	PARA-FOR	MAT
F-23W	90	0,8	3,3	45	6	Capri - Capri S. - Neo -Dakki - Xcode	W
F-24	95	1		45	6	Capri - Capri S. - Neo -Dakki - Xcode	HSS
F-24W	95	1		45	6	Capri - Capri S. - Neo -Dakki - Xcode	W
F-25	95	1,1		45	6	Capri - Capri S. - Neo -Dakki - Xcode	HSS
F-25W	95	1,1		45	6	Capri - Capri S. - Neo -Dakki - Xcode	W
F-26	90	0,6	1,8	45	6	Capri - Capri S. - Neo -Dakki - Xcode	HSS
F-27	90	0,7		45	6	Capri - Capri S. - Neo -Dakki - Xcode	HSS
F-27W	90	0,7		45	6	Capri - Capri S. - Neo -Dakki - Xcode	W
F-29W	100	0,6		45	6	Capri - Capri S. - Neo -Dakki - Xcode	W
F-30W	100	0,5		45	6	Capri - Capri S. - Neo -Dakki - Xcode	W
F-31W	90	0,6		45	6	Capri - Capri S. - Neo -Dakki - Xcode	W
F-32	90	0,6	3	45	6	Capri - Capri S. - Neo -Dakki - Xcode	HSS
F-32W	90	0,6	3	45	6	Capri - Capri S. - Neo -Dakki - Xcode	W
F-33			2	45	6	Capri - Capri S. - Neo -Dakki - Xcode	HSS
F-33W			2	45	6	Capri - Capri S. - Neo -Dakki - Xcode	W
F-34	90	1,4		45	6	Capri - Capri S. - Neo -Dakki - Xcode	HSS
F-35W		3	3	45	6	Capri - Capri S. - Neo -Dakki - Xcode	W
F-40	90	0,2		45	6	Capri - Capri S. - Neo -Dakki - Xcode	HSS
F-43	90	0,7	2,6	45	6	Capri - Capri S. - Neo -Dakki - Xcode	HSS
F-B	90	2,7-3,3		45	6	Capri - Capri S. - Neo -Dakki - Xcode	HSS
F-BW	90	2,7-3,3		45	6	Capri - Capri S. - Neo -Dakki - Xcode	W
F-C	80	1,4-2		45	6	Capri - Capri S. - Neo -Dakki - Xcode	HSS
F-CW	80	1,4-2		45	6	Capri - Capri S. - Neo -Dakki - Xcode	W
F-S31	60	0,64-1,2		45	6	Capri - Capri S. - Neo -Dakki - Xcode	HSS

CODE	F	G	C	D	E	PARA-FOR	MAT
F-18	10	1		45	6	Capri - Capri Smart - Xcode	HSS
F-36	12	2		45	6	Xcode	HSS
F-37		1,3		45	6	Xcode	W

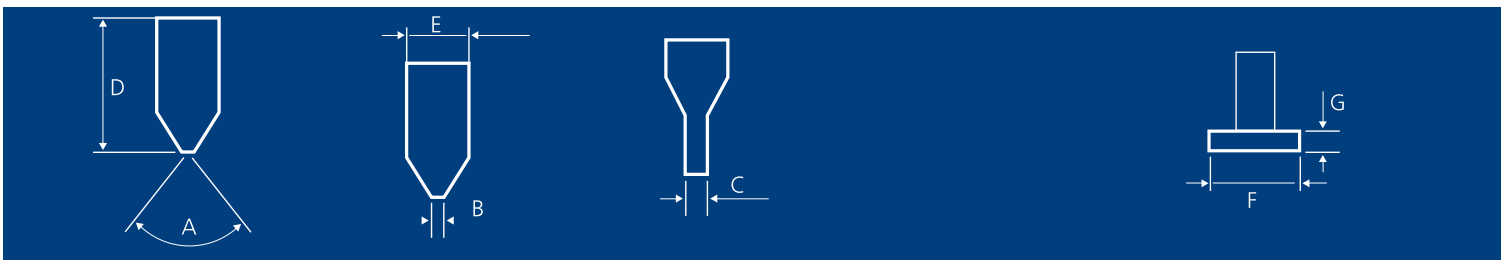

## SIMBOLOGÍA SYMBOLS

**W** Fresa de metal duro  
Metal gororreko fresa  
Hard metal cutters  
Fraise en métal dur  
Fräsen für Hartmetall

**Ángulo de corte**  
Ebaketa-angelua  
Cutting angle  
Angle de coupe  
Schnittwinkel

**HSS** Acero extra rápido  
Altzairu estra azkarra  
High-speed steel  
Acier extra rapide  
Extraschneller Stahl

**Base**  
Oinarri  
Base  
Base  
Basis

**Diámetro**  
Diámetro  
Diameter  
Diámetro  
Durchmesser

**Distancia corte**  
Ebaketaren distantzia  
Cutting distance  
Distance coupe  
Schnittabstand

**Altura de corte**  
Ebaketa altuera  
Cutting height  
Hauteur de coupe  
Schnitthöhe

**Largo**  
Luzera  
Length  
Longueur  
Länge

**Diámetro de corte**  
Ebaketa diámetro  
Cutting diameter  
Diámetro de coupe  
Schneidmesser



## FRESAS CUTTERS

F-1	F-1A	F-1W	F-3	F-3W	F-4	F-5	F-5W	F-6	F-7	F-8	F-8W	F-9	F-9W	F-11	F-11W	F-12A	F-12B	F-13	F-13W	F-14
F-15	F-16	F-17	F-17W	F-18	F-19	F-19W	F-21	F-22	F-23	F-23W	F-24	F-24W	F-25	F-25W	F-26	F-27	F-27W	F-29W	F-30W	F-31W
F-32	F-32W	F-33	F-33W	F-34	F-35W	F-36	F-37	F-40	F-43	F-B	F-BW	F-C	F-CW	F-S31						



## PALPADORES TRACERS

P-1	P-3	P-4	P-5	P-6	P-7	P-8	P-11	P-12A	P-12B	P-13	P-14	P-15	P-16	P-17	P-19	P-21	P-22	P-23	P-26
P-32	P-33	P-34	P-40	P-43	PS31	P-12X	P-B	P-C											



## ADAPTADORES ADAPTORS

AD-15°	AD-45°	AD-5°	AD-AU	AD-B6	AD-BKS
AD-BR	AD-CI	AD-DO	AD-FO	AD-FO24	AD-JAR1E
AD-JIS	AD-MCM	AD-MJ	AD-MM	AD-OP	AD-PFA
AD-STS	AD-T12P	AD-VA58	AD-VAX	AD-X03	AD-X04

ADAPTADOR	CAPRI	CAPRI S.	NEO	DAKKI	XCODE
AD-15°		X	X	X	
AD-45°		X	X	X	
AD-5°		X	X	X	X
AD-AU					X
AD-B6	X	X	X	X	
AD-BKS	X	X	X	X	
AD-BR	X	X	X	X	X
AD-CI	X	X	X	X	
AD-DO	X	X	X	X	
AD-FO	X	X	X	X	
AD-FO24			X	X	

ADAPTADOR	CAPRI	CAPRI S.	NEO	DAKKI	XCODE
AD-JAR1E	X	X	X	X	
AD-JIS	X	X	X	X	
AD-MCM			X	X	
AD-MJ	X	X	X	X	
AD-MM	X	X	X	X	
AD-OP	X	X	X	X	
AD-PFA	X	X	X	X	
AD-STS	X	X	X	X	X
AD-T12P	X	X	X	X	
AD-VA58		X	X	X	
AD-VAX	X	X	X	X	

# SEGURIDAD SECURITY

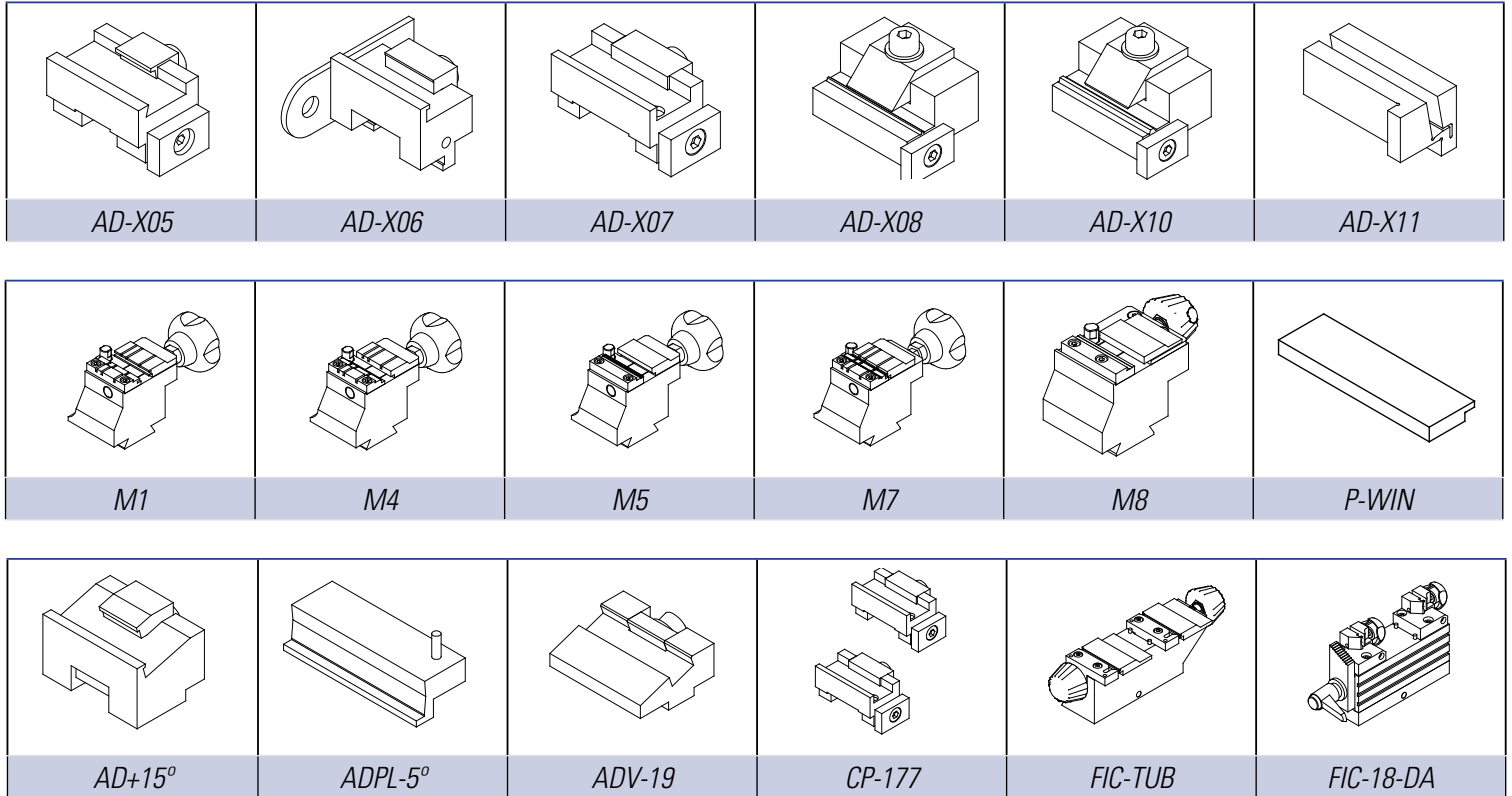

ADAPTADOR	CAPRI	CAPRI S.	NEO	DAKKI	XCODE
AD-X03					X
AD-X04					X
AD-X05					X
AD-X06					X
AD-X07					X
AD-X08					X
AD-X10					X
AD-X11					X
AD+15°					X
ADPL-5°	X	X	X	X	X
ADV-19					X

ADAPTADOR	CAPRI	CAPRI S.	NEO	DAKKI	XCODE
CP-177	X	X	X	X	
FIC-TUB		X			
FIC-18-DA	X	X			
M1					X
M4					X
M5					X
M7					X
M8					X
P-WIN		X	X	X	



**MÁQUINA PARA LLAVES DE SEGURIDAD**  
SEGURTASUN GILTZATARAKO MAKINAK  
MACHINES FOR SECURITY KEYS  
MACHINES POUR CLES DE SECURITE  
MASCHINEN FÜR SICHERHEITSSCHLÜSSEL



**FRESAS**  
FRESAK  
CUTTERS  
FRAISES  
FRÄSEN



**PALPADORES**  
HAZTAGAILUAK  
TRACERS  
PALPEURS  
FÜHLER



**ACCESORIOS**  
OSAGARRIAK  
ACCESSORIES  
ADAPTATEURS  
ZUBEHÖR

**CAPRI**

**CAPRI**

**CAPRI S.**

**CAPRI SMART**

**NEO**

**NEO**

**DAKKI**

**DAKKI**

**XCODE**

**XCODE**



# **FICHA ESPECIALISTA**

ESPEZIALISTAREN FITXA

SPECIALIST FILE

FICHE SPÉCIALISÉE

DATENBLATT FÜR FACHLEUTE

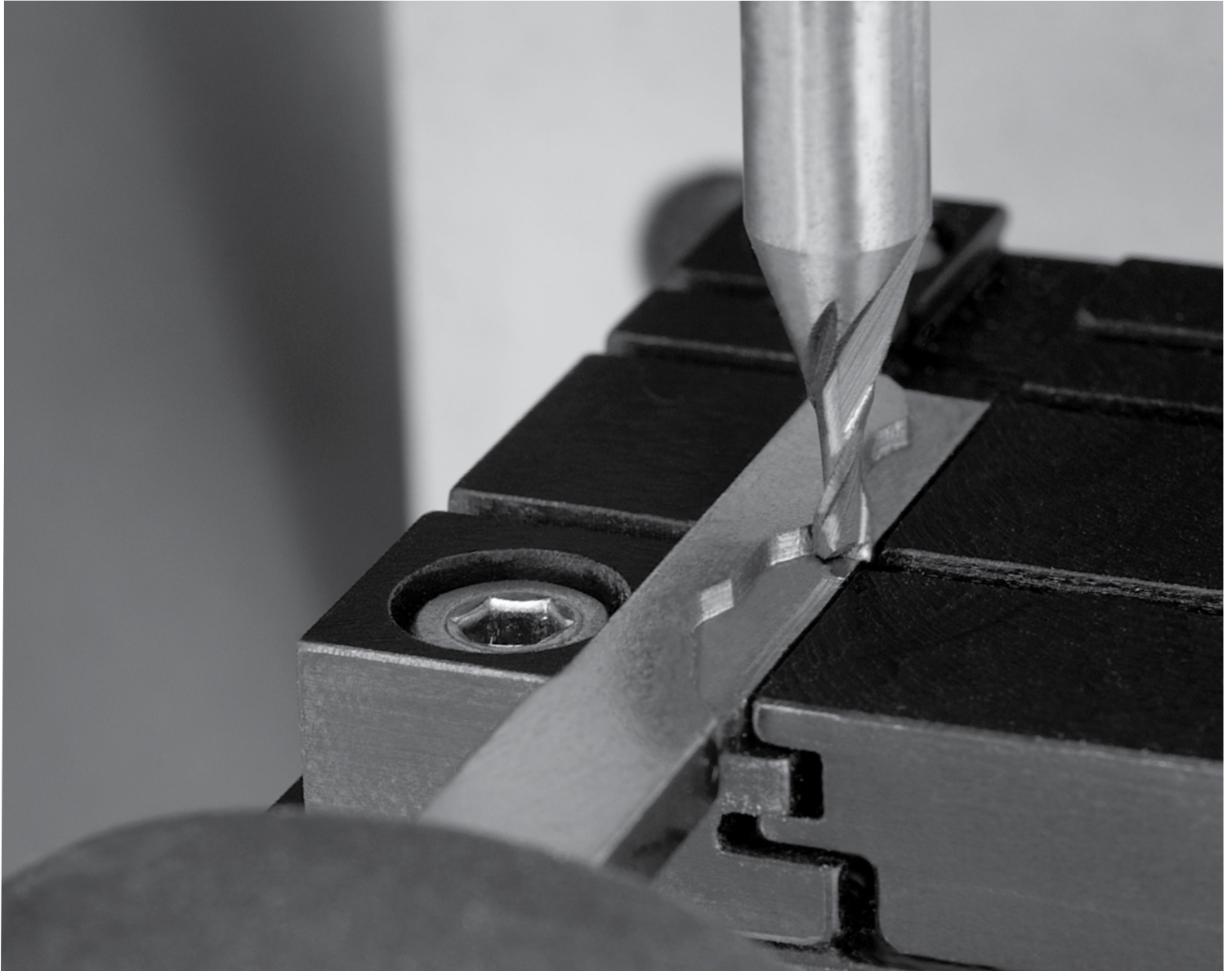

***CAPRI - CAPRI S. - NEO - DAKKI - XCODE***

***PARA LLAVES DE SEGURIDAD***

*SEGURITATEZKO GILTZENTZAT*







*FOR SECURITY KEYS*







*POUR CLES DE SECURITE*

*FÜR SICHERHEITSSCHLÜSSEL*







***THE KEY TO EXCELLENCE***







*GLOBALLY UNLOCKING MILLIONS OF DOORS DAILY*





							
<b>ABSA</b>	AB-1T	CAPRI	F-8	P-8			
		CAPRI S.	F-8	P-8	FIC-TUB		
	AB-2T	CAPRI	F-8	P-8			
		CAPRI S.	F-8	P-8	FIC-TUB		
	AB-3T	CAPRI	F-8	P-8			
		CAPRI S.	F-8	P-8	FIC-TUB		
AB-4T	CAPRI	F-8	P-8				
	CAPRI S.	F-8	P-8	FIC-TUB			
<b>ABC</b>	ABC-6	CAPRI	F-5	P-5			
		CAPRI S.	F-5	P-5			
		XCODE	F-13W				
		NEO-DAKKI	F-5	P-5			
	ABC-7	CAPRI	F-5	P-5			
		CAPRI S.	F-5	P-5			
	NEO-DAKKI	F-5	P-5				
<b>ABLOY</b>	ABU-16	CAPRI	F-1	P-1			
		CAPRI S.	F-1	P-1			
		NEO-DAKKI	F-1	P-1			
		XCODE	F-1W	P-1			
<b>ABUS</b>	ABU-34	CAPRI	F-1	P-1	AD-CI		
		CAPRI S.	F-1	P-1	AD-CI		
		NEO-DAKKI	F-1	P-1	AD-CI		
		XCODE	F-1W				
	ABU-61	CAPRI	F-1	P-1	AD-CI		
		CAPRI S.	F-1	P-1	AD-CI		
		NEO-DAKKI	F-1	P-1	AD-CI		
		XCODE	F-1W				
	ABU-63	CAPRI	F-1	P-1	AD-CI		
		CAPRI S.	F-1	P-1	AD-CI		
		NEO-DAKKI	F-1	P-1	AD-CI		
		XCODE	F-1W				
	ABU-66	CAPRI	F-1	P-1	AD-CI		
		CAPRI S.	F-1	P-1	AD-CI		
		NEO-DAKKI	F-1	P-1	AD-CI		
		XCODE	F-1W				
	ABU-81	CAPRI	F-1	P-1	AD-CI		
		CAPRI S.	F-1	P-1	AD-CI		
		NEO-DAKKI	F-1	P-1	AD-CI		
		XCODE	F-1W				
	<b>AGA</b>	AGA-12	CAPRI	F-13	P-13		
			CAPRI S.	F-13	P-13		
			NEO-DAKKI	F-13	P-13		
			XCODE	F-27			





						
<b>AGA</b>	AGA-25	CAPRI	F-13	P-13		
		CAPRI S.	F-13	P-13		
		NEO-DAKKI	F-13	P-13		
	AGA-1T	CAPRI	F-8	P-8		
		CAPRI S.	F-8	P-8	FIC-TUB	
	AGA-29	CAPRI	F-5	P-5		
		CAPRI S.	F-5	P-5		
		NEO-DAKKI	F-5	P-5		
		XCODE	F-1W			
	AGA-2T	CAPRI	F-8	P-8		
		CAPRI S.	F-8	P-8	FIC-TUB	
	AGA-38	CAPRI	F-1	P-1		
		CAPRI S.	F-1	P-1		
		NEO-DAKKI	F-1	P-1		
		NEO-DAKKI	F-1W			
	AGA-39	CAPRI	F-1	P-1		
		CAPRI S.	F-1	P-1		
		NEO-DAKKI	F-1	P-1		
		XCODE	F-1W			
	AGA-42	CAPRI	F-1	P-1		
		CAPRI S.	F-1	P-1		
		NEO-DAKKI	F-1	P-1		
		XCODE	F-1W			
	AGA-43	CAPRI	F-1	P-1		
CAPRI S.		F-1	P-1			
NEO-DAKKI		F-1	P-1			
XCODE		F-1W				
AGA-44	CAPRI	F-1	P-1			
	CAPRI S.	F-1	P-1			
	NEO-DAKKI	F-1	P-1			
	XCODE	F-1W				
AGA-48	CAPRI	F-1	P-1			
	CAPRI S.	F-1	P-1			
	NEO-DAKKI	F-1	P-1			
	XCODE	F-1W				
AGA-49	CAPRI	F-1	P-1			
	CAPRI S.	F-1	P-1			
	NEO-DAKKI	F-1	P-1			
	XCODE	F-1W				
AGA-50	CAPRI	F-1	P-1			
	CAPRI S.	F-1	P-1			

# SEGURIDAD SECURITY







						
<b>AGA</b>		NEO-DAKKI	F-1	P-1		
		XCODE	F-1W			
<b>AGB</b>	AGB-2	CAPRI	F-1	P-1		
		CAPRI S.	F-1	P-1		
		NEO-DAKKI	F-1	P-1		
		XCODE	F-27			
	AGB-4	CAPRI	F-1	P-1		
		CAPRI S.	F-1	P-1		
		NEO-DAKKI	F-1	P-1		
		XCODE	F-27			
	AGB-5	CAPRI	F-1	P-1		
		CAPRI S.	F-1	P-1		
		NEO-DAKKI	F-1	P-1		
		XCODE	F-27			
	<b>AMIG</b>	AMG-10	CAPRI	F-5	P-5	
			CAPRI S.	F-5	P-5	
NEO-DAKKI			F-5	P-5		
AMG-10D		CAPRI	F-5	P-5		
		CAPRI S.	F-5	P-5		
		NEO-DAKKI	F-5	P-5		
AMG-8D		CAPRI	F-5	P-5		
		CAPRI S.	F-5	P-5		
		NEO-DAKKI	F-5	P-5		
AMG-9D		CAPRI	F-5	P-5		
		CAPRI S.	F-5	P-5		
		NEO-DAKKI	F-5	P-5		
<b>APEX</b>		AP-1D	CAPRI	F-13	P-13	
			CAPRI S.	F-13	P-13	
	NEO-DAKKI		F-13	P-13		
	AP-3D	CAPRI	F-13	P-13		
		CAPRI S.	F-13	P-13		
		NEO-DAKKI	F-13	P-13		
	AP-4D	CAPRI	F-13	P-13		
		CAPRI S.	F-13	P-13		
		NEO-DAKKI	F-13	P-13		
	AP-5D	CAPRI	F-19	P-19		
		CAPRI S.	F-19	P-19		
		NEO-DAKKI	F-19	P-19		
<b>AXA</b>	AX-2P	CAPRI	F-33	P-33		
		CAPRI S.	F-33	P-33		
		NEO-DAKKI	F-33	P-33		





					
<b>AXA</b>		XCODE	F-33		
<b>AZBE</b>	AZ-12	CAPRI	F-13	P-13	
		CAPRI S.	F-13	P-13	
		NEO-DAKKI	F-13	P-13	
	AZ-14	CAPRI	F-13	P-13	
		CAPRI S.	F-13	P-13	
		NEO-DAKKI	F-13	P-13	
		XCODE	F-5W		
	AZ-7	CAPRI	F-15	P-15	
		CAPRI S.	F-15	P-15	
		NEO-DAKKI	F-15	P-15	P-WIN
	AZ-8D	CAPRI	F-5	P-5	
		CAPRI S.	F-5	P-5	
		NEO-DAKKI	F-5	P-5	
	AZ-8D	XCODE	F-5W		
	AZ-9	CAPRI	F-13	P-13	
		CAPRI S.	F-13	P-13	
		NEO-DAKKI	F-13	P-13	
	AZ-9D	CAPRI	F-13	P-13	
		CAPRI S.	F-13	P-13	
		NEO-DAKKI	F-13	P-13	
	AZ-29	CAPRI	F-13	P-13	
		CAPRI S.	F-13	P-13	
		NEO-DAKKI	F-13	P-13	
	AZ-32	CAPRI	F-13	P-13	
CAPRI S.		F-13	P-13		
NEO-DAKKI		F-13	P-13		
<b>BAGEM</b>	BAG-1	CAPRI	F-1	P-1	
		CAPRI S.	F-1	P-1	
		NEO-DAKKI	F-1	P-1	
		XCODE	F-1W		
<b>BAODEAN</b>	BDA-1	CAPRI	F-14	P-14	
		CAPRI S.	F-14	P-14	
		NEO-DAKKI	F-14	P-14	
		XCODE	F-14		
<b>BASI</b>	BAI-8D	CAPRI	F-5	P-5	
		CAPRI S.	F-5	P-5	
		NEO-DAKKI	F-5	P-5	

®	JMA				
<b>BASI</b>	BAI-9D	CAPRI	F-5	P-5	
		CAPRI S.	F-5	P-5	
		NEO-DAKKI	F-5	P-5	
	ORIGINAL CX6	XCODE	F-19		
<b>BEY</b>	BEY-1D	CAPRI	F-13	P-13	
		CAPRI S.	F-13	P-13	
		NEO-DAKKI	F-13	P-13	
		XCODE	F-13W		
	BEY-2D	CAPRI	F-19	P-19	
		CAPRI S.	F-19	P-19	
		NEO-DAKKI	F-19	P-19	
<b>BILMA</b>	BIL-1T	CAPRI	F-8	P-8	
		CAPRI S.	F-8	P-8	FIG-TUB
<b>BKS</b>	ORIGINAL WS 50 NW	CAPRI	F-35W	P-35	AD-BKS
		CAPRI S.	F-35W	P-35	AD-BKS
		NEO-DAKKI	F-35W	P-35	AD-BKS
		XCODE	F-35W		AD-X10
	ORIGINAL WS 50 RA, RK, RZ	XCODE	F-35W		AD-X08
<b>BORKEY</b>	BKY-1	CAPRI	F-1	P-1	
		CAPRI S.	F-1	P-1	
		NEO-DAKKI	F-1	P-1	
		XCODE	F-5W		
	BKY-2	CAPRI	F-1	P-1	
		CAPRI S.	F-1	P-1	
		NEO-DAKKI	F-1	P-1	
<b>BRAS</b>	BRAS-1	CAPRI	F-13	P-13	
		CAPRI S.	F-13	P-13	
		NEO-DAKKI	F-13	P-13	
<b>BRICARD</b>	BRI-16	CAPRI	F-1	P-1	
		CAPRI S.	F-1	P-1	
		NEO-DAKKI	F-1	P-1	
		XCODE	F-5W		
	BRI-25	CAPRI	F-1	P-1	AD-CI
		CAPRI S.	F-1	P-1	AD-CI
		NEO-DAKKI	F-1	P-1	AD-CI
	BRI-26	CAPRI	F-1	P-1	AD-CI
		NEO-DAKKI	F-1	P-1	AD-CI
		CAPRI S.	F-1	P-1	AD-CI
BRI-27	CAPRI	F-1	P-1	AD-CI	







®	JMA				
<b>BRICARD</b>		CAPRI S.	F-1	P-1	AD-CI
		NEO-DAKKI	F-1	P-1	AD-CI
	BRI-28	CAPRI	F-1	P-1	AD-CI
		CAPRI S.	F-1	P-1	AD-CI
		NEO-DAKKI	F-1	P-1	AD-CI
	BRI-29	CAPRI	F-1	P-1	AD-CI
		CAPRI S.	F-1	P-1	AD-CI
		NEO-DAKKI	F-1	P-1	AD-CI
		XCODE	F-1W		AD-X03
	BRI-30	CAPRI	F-1	P-1	AD-CI
CAPRI S.		F-1	P-1	AD-CI	
NEO-DAKKI		F-1	P-1	AD-CI	
BRI-31	CAPRI	F-1	P-1	AD-CI	
	CAPRI S.	F-1	P-1	AD-CI	
	NEO-DAKKI	F-1	P-1	AD-CI	
BRI-33	CAPRI	F-1	P-1	AD-CI	
	CAPRI S.	F-1	P-1	AD-CI	
	NEO-DAKKI	F-1	P-1	AD-CI	
BRI-34	CAPRI	F-1	P-1	AD-CI	
	CAPRI S.	F-1	P-1	AD-CI	
	NEO-DAKKI	F-1	P-1	AD-CI	
	ORIGINAL DUAL XP	XCODE	F-1W		
<b>BULAT</b>	BUL-1	NEO-DAKKI	F-1	P-1	
		CAPRI S.	F-1	P-1	
		CAPRI	F-1	P-1	
<b>BURG</b>	BUR-33	NEO-DAKKI	F-1	P-1	
		CAPRI S.	F-1	P-1	
		CAPRI	F-1	P-1	
<b>BYP</b>	BYP-1D	CAPRI	F-19	P-19	
		CAPRI S.	F-19	P-19	
		NEO-DAKKI	F-19	P-19	
<b>CAYS</b>	CAY-2	CAPRI	F-1	P-1	
		CAPRI S.	F-1	P-1	
		NEO-DAKKI	F-1	P-1	
		XCODE	F-19		
<b>CES</b>	CE-114	CAPRI	F-32	P-32	
		CAPRI S.	F-32	P-32	
		NEO-DAKKI	F-32	P-32	
		XCODE	F-32		
	ORIGINAL WSM	CAPRI	F-32	P-32	
		CAPRI S.	F-32	P-32	







# SEGURIDAD SECURITY

					
<b>CES</b>	NEO-DAKKI	F-32	P-32		
	XCODE	F-32			
<b>CHICAGO</b>	CHI-1T	CAPRI	F-8	P-8	
		CAPRI S.	F-8	P-8	FIC-TUB
<b>CHUBB</b>	CHU-10	CAPRI	F-1	P-1	
		CAPRI S.	F-1	P-1	
		NEO-DAKKI	F-1	P-1	
<b>CISA</b>	CI-14	CAPRI	F-1	P-1	
		CAPRI S.	F-1	P-1	
		NEO-DAKKI	F-1	P-1	
		XCODE	F-5W		
	CI-17	CAPRI	F-1	P-1	
		CAPRI S.	F-1	P-1	
		NEO-DAKKI	F-1	P-1	
		XCODE	F-43		
	CI-21	CAPRI	F-1	P-1	AD-CI
		CAPRI S.	F-1	P-1	AD-CI
		NEO-DAKKI	F-1	P-1	AD-CI
		XCODE	F-1W		
	CI-25	CAPRI	F-1	P-1	AD-CI
		CAPRI S.	F-1	P-1	AD-CI
		NEO-DAKKI	F-1	P-1	AD-CI
		XCODE	F-1W		
	CI-26	CAPRI	F-1	P-1	AD-CI
		CAPRI S.	F-1	P-1	AD-CI
		NEO-DAKKI	F-1	P-1	AD-CI
		XCODE	F-1W		
	CI-30	CAPRI	F-1	P-1	AD-CI
		CAPRI S.	F-1	P-1	AD-CI
		NEO-DAKKI	F-1	P-1	AD-CI
		XCODE	F-1W		
	CI-31	CAPRI	F-1	P-1	AD-CI
		CAPRI S.	F-1	P-1	AD-CI
		NEO-DAKKI	F-1	P-1	AD-CI
		XCODE	F-1W		AD-X03
	CI-32	CAPRI	F-1	P-1	AD-CI
		NEO-DAKKI	F-1	P-1	AD-CI
		CAPRI S.	F-1	P-1	AD-CI
		XCODE	F-1W		AD-X03
CI-33	CAPRI	F-1	P-1	AD-CI	
	CAPRI S.	F-1	P-1	AD-CI	







					
<b>CISA</b>	NEO-DAKKI	F-1	P-1	AD-CI	
	XCODE	F-1W			
	CI-35	CAPRI	F-1	P-1	AD-CI
		CAPRI S.	F-1	P-1	AD-CI
		NEO-DAKKI	F-1	P-1	AD-CI
		XCODE	F-1W		AD-X03
	CI-48	CAPRI	F-1	P-1	AD-CI
		CAPRI S.	F-1	P-1	AD-CI
		NEO-DAKKI	F-1	P-1	AD-CI
	CI-56	CAPRI	F-1	P-1	AD-CI
		CAPRI S.	F-1	P-1	AD-CI
	CI-57	CAPRI	F-1	P-1	AD-CI
		CAPRI S.	F-1	P-1	AD-CI
		NEO-DAKKI	F-1	P-1	AD-CI
	CI-59	CAPRI	F-1	P-1	
		CAPRI S.	F-1	P-1	
		NEO-DAKKI	F-1	P-1	
	CI-60	CAPRI	F-1	P-1	AD-CI
		CAPRI S.	F-1	P-1	AD-CI
		NEO-DAKKI	F-1	P-1	AD-CI
	CI-66	CAPRI	F-1	P-1	AD-CI
		CAPRI S.	F-1	P-1	AD-CI
		NEO-DAKKI	F-1	P-1	AD-CI
	CI-71	CAPRI	F-1	P-1	AD-CI
		CAPRI S.	F-1	P-1	AD-CI
		NEO-DAKKI	F-1	P-1	AD-CI
	CI-72	CAPRI	F-1	P-1	AD-CI
		CAPRI S.	F-1	P-1	AD-CI
		NEO-DAKKI	F-1	P-1	AD-CI
	CI-73	CAPRI	F-1	P-1	AD-CI
		CAPRI S.	F-1	P-1	AD-CI
		NEO-DAKKI	F-1	P-1	AD-CI
<b>CORBIN</b>	COR-37	CAPRI	F-5	P-5	
		CAPRI S.	F-5	P-5	
		NEO-DAKKI	F-5	P-5	
		XCODE	F-19		
	COR-77	CAPRI	F-5	P-5	
		CAPRI S.	F-5	P-5	
NEO-DAKKI		F-5	P-5		
	XCODE	F-19			













					
<b>CORBIN</b>	ORIGINAL EUROVAL	XCODE	F-5W		
<b>CVL</b>	CVL-9D	CAPRI	F-13	P-13	
		CAPRI S.	F-13	P-13	
		NEO-DAKKI	F-13	P-13	
		NEO-DAKKI	F-13W		
<b>DAF</b>	DAF-2	CAPRI	F-13	P-13	
		CAPRI S.	F-13	P-13	
		NEO-DAKKI	F-13	P-13	
	DAF-3D	CAPRI	F-13	P-13	
		CAPRI S.	F-13	P-13	
		NEO-DAKKI	F-13	P-13	
	DAF-4D	CAPRI	F-13	P-13	
		CAPRI S.	F-13	P-13	
		NEO-DAKKI	F-13	P-13	
<b>DEKABA</b>	DEK-3	CAPRI	F-1	P-1	
		CAPRI S.	F-1	P-1	
		NEO-DAKKI	F-1	P-1	
		XCODE	F-6		
<b>DEKABA</b>	DEK-4	CAPRI	F-1	P-1	
		CAPRI S.	F-1	P-1	
		NEO-DAKKI	F-1	P-1	
	DEK-8	CAPRI	F-1	P-1	
		CAPRI S.	F-1	P-1	
		NEO-DAKKI	F-1	P-1	
		XCODE	F-6		
	DEK-11	CAPRI	F-1	P-1	
		CAPRI S.	F-1	P-1	
		NEO-DAKKI	F-1	P-1	
<b>DELCA</b>	DLC-1	CAPRI	F-1	P-1	
		CAPRI S.	F-1	P-1	
		NEO-DAKKI	F-1	P-1	
	DLC-2	CAPRI	F-1	P-1	
		CAPRI S.	F-1	P-1	
		NEO-DAKKI	F-1	P-1	
	DLC-3	CAPRI	F-1	P-1	
		CAPRI S.	F-1	P-1	
		NEO-DAKKI	F-1	P-1	
<b>DIERRE</b>	DR-1	CAPRI	F-11	P-11	
		CAPRI S.	F-11	P-11	
		NEO-DAKKI	F-11	P-11	





					
<b>DOM</b>	DOM-17I	CAPRI	F-1	P-1	
		CAPRI S.	F-1	P-1	
		NEO-DAKKI	F-1	P-1	
		XCODE	F-1W		
	DOM-22	CAPRI	F-1	P-1	
		CAPRI S.	F-1	P-1	
		NEO-DAKKI	F-1	P-1	
		XCODE	F-1W		
	DOM-30	CAPRI	F-1	P-1	
		CAPRI S.	F-1	P-1	
		NEO-DAKKI	F-1	P-1	
		XCODE	F-1W		
	DOM-31	CAPRI	F-1	P-1	AD-ST5
		CAPRI S.	F-1	P-1	AD-ST5
		NEO-DAKKI	F-1	P-1	AD-ST5
		XCODE	F-1W		
	DOM-32	CAPRI	F-1	P-1	AD-ST5
		CAPRI S.	F-1	P-1	AD-ST5
		NEO-DAKKI	F-1	P-1	AD-ST5
	DOM-33	CAPRI	F-1	P-1	AD-ST5
CAPRI S.		F-1	P-1	AD-ST5	
NEO-DAKKI		F-1	P-1	AD-ST5	
XCODE		F-1W			
DOM-34	CAPRI	F-1	P-1	AD-ST5	
	CAPRI S.	F-1	P-1	AD-ST5	
	NEO-DAKKI	F-1	P-1	AD-ST5	
	XCODE	F-1W			
DOM-39	CAPRI	F-1	P-1	AD-ST5	
	CAPRI S.	F-1	P-1	AD-ST5	
	NEO-DAKKI	F-1	P-1	AD-ST5	
	XCODE	F-1W			
DOM-43	CAPRI	F-1	P-1	AD-ST5	
	CAPRI S.	F-1	P-1	AD-ST5	
	NEO-DAKKI	F-1	P-1	AD-ST5	
DOM-56D	CAPRI	F-1	P-1		
	CAPRI S.	F-1	P-1		
	NEO-DAKKI	F-1	P-1		
DOM-63D	CAPRI	F-1	P-1		
	CAPRI S.	F-1	P-1		
	NEO-DAKKI	F-1	P-1		

# SEGURIDAD SECURITY







					
<b>DOM</b>	DOM-B1	CAPRI	F-1	P-1	
		CAPRI S.	F-1	P-1	
		NEO-DAKKI	F-1	P-1	
	ORIGINAL IX5 DAS 038	CAPRI	F-1	P-1	AD-DO
		CAPRI S.	F-1	P-1	AD-DO
		NEO-DAKKI	F-1	P-1	AD-DO
		XCODE	F-1W		M4
	ORIGINAL IX DAS 138	CAPRI	F-23	P-23	
		CAPRI S.	F-23	P-23	
		NEO-DAKKI	F-23	P-23	
		XCODE	F-23W		M1
	ORIGINAL IX6 KG 102/121	CAPRI	F-1A	P-1	AD-DO
		CAPRI S.	F-1A	P-1	AD-DO
		NEO-DAKKI	F-1A	P-1	AD-DO
		XCODE	F-1A		M4
ORIGINAL IX6 SR 132/232	CAPRI	F-23	P-23	AD-DO	
	CAPRI S.	F-23	P-23	AD-DO	
	NEO-DAKKI	F-23	P-23	AD-DO	
	XCODE	F-23W		M4	
DOM-B6	CAPRI	F-1A	P-23	AD-B6	
	CAPRI S.	F-1A	P-23	AD-B6	
	NEO-DAKKI	F-1A	P-23	AD-B6	
<b>DOMUS</b>	DO-3	CAPRI	F-1	P-1	
		CAPRI S.	F-1	P-1	
		NEO-DAKKI	F-1	P-1	
		XCODE	F-43		
	DO-4	CAPRI	F-1	P-1	
		CAPRI S.	F-1	P-1	
		NEO-DAKKI	F-1	P-1	
<b>ELZETT</b>	ELZ-10	CAPRI	F-5	P-5	
		CAPRI S.	F-5	P-5	
		NEO-DAKKI	F-5	P-5	
		XCODE	F-5W		
	ELZ-10D	CAPRI	F-5	P-5	
		NEO-DAKKI	F-5	P-5	
		CAPRI S.	F-5	P-5	
<b>EUROLOCKS</b>	EU-12	CAPRI	F-33	P-33	
		NEO-DAKKI	F-33	P-33	
		CAPRI S.	F-33	P-33	
<b>EZCURRA</b>	EZ-DS10	CAPRI	F-1	P-1	
			F-16	P-16	







						
<b>EZCURRA</b>	CAPRI S.	F-1	P-1			
		F-16	P-16			
		NEO-DAKKI	F-1	P-1		
		F-16	P-16			
		XCODE	F-27			
	EZ-DS10E	CAPRI	F-1	P-1		
			F-16	P-16		
		CAPRI S.	F-1	P-1		
		NEO-DAKKI	F-1	P-1		
			F-16	P-16		
		XCODE	F-5W			
	EZ-DS15	CAPRI	F-1	P-1		
			F-16	P-16		
		CAPRI S.	F-1	P-1		
		NEO-DAKKI	F-1	P-1		
		F-16	P-16			
		F-16	P-16			
EZ-DS15R	CAPRI	F-1	P-1			
		F-16	P-16			
	CAPRI S.	F-1	P-1			
	NEO-DAKKI	F-1	P-1			
		F-16	P-16			
		F-16	P-16			
<b>FAC</b>	FAC-19	CAPRI	F-1	P-1		
		CAPRI S.	F-1	P-1		
		NEO-DAKKI	F-1	P-1		
		XCODE	F-5W			
FAC-23	CAPRI	F-1	P-1			
	CAPRI S.	F-1	P-1			
	NEO-DAKKI	F-1	P-1			
	XCODE	F-1W				
FAC-24	CAPRI	F-1	P-1			
	CAPRI S.	F-1	P-1			
	NEO-DAKKI	F-1	P-1			
<b>FAVOUR</b>	FAV-1D	CAPRI	F-5	P-5		
		CAPRI S.	F-5	P-5		
		NEO-DAKKI	F-5	P-5		
		XCODE	F-19			
FAV-2	CAPRI	F-5	P-5			

®	JMA				
<b>FAVOUR</b>		CAPRI S.	F-5	P-5	
		NEO-DAKKI	F-5	P-5	
<b>FAYN</b>	FAY-1D	CAPRI	F-5	P-5	
		CAPRI S.	F-5	P-5	
		NEO-DAKKI	F-5	P-5	
<b>F-CV</b>	FV-3	CAPRI	F-5	P-5	
		CAPRI S.	F-5	P-5	
		NEO-DAKKI	F-5	P-5	
<b>FF</b>	FF-13	CAPRI	F-13	P-13	
		CAPRI S.	F-13	P-13	
		NEO-DAKKI	F-13	P-13	
<b>FICHET</b>	FIC-2	CAPRI	F-11	P-11	
		CAPRI S.	F-11	P-11	FIC-TUB
	FIC-3	CAPRI	F-11	P-11	
		CAPRI S.	F-11	P-11	FIC-TUB
	FIC-4	CAPRI	F-11	P-11	
		CAPRI S.	F-11	P-11	FIC-TUB
	FIC-18	CAPRI	F-18	P-18	FIC-18-DA
		CAPRI S.	F-18	P-18	FIC-18-DA
<b>FORD</b>	FO-6P	CAPRI	F-22	P-22	AD-FO
		CAPRI S.	F-22	P-22	AD-FO
		NEO-DAKKI	F-22	P-22	AD-FO
	FO-24P	CAPRI	F-11	P-11	
		CAPRI S.	F-11	P-11	
		NEO-DAKKI	F-11	P-11	AD-FO24
	XCODE	F-11W			
<b>FONTAINE</b>	FON-1E	CAPRI	F-8	P-8	
		CAPRI S.	F-8	P-8	FIC-TUB
	FON-2E	CAPRI	F-8	P-8	
		CAPRI S.	F-8	P-8	FIC-TUB
	FON-3E	CAPRI	F-8	P-8	
		CAPRI S.	F-8	P-8	FIC-TUB
	FON-5E	CAPRI	F-8	P-8	
		CAPRI S.	F-8	P-8	FIC-TUB
<b>FTH</b>	FTH-16	CAPRI	F-5	P-5	
		CAPRI S.	F-5	P-5	
		NEO-DAKKI	F-5	P-5	
		XCODE	F-19		
	FTH-23	CAPRI	F-5	P-5	

®	JMA				
<b>FTH</b>		CAPRI S.	F-5	P-5	
		NEO-DAKKI	F-5	P-5	
		XCODE	F-1W		
	FTH-24	CAPRI	F-5	P-5	
		CAPRI S.	F-5	P-5	
		NEO-DAKKI	F-5	P-5	
	FTH-25	CAPRI	F-5	P-5	
		CAPRI S.	F-5	P-5	
		NEO-DAKKI	F-5	P-5	
	FTH-26D	CAPRI	F-5	P-5	
		CAPRI S.	F-5	P-5	
		NEO-DAKKI	F-5	P-5	
FTH-29	CAPRI	F-5	P-5		
	CAPRI S.	F-5	P-5		
	NEO-DAKKI	F-5	P-5		
FTH-30	CAPRI	F-5	P-5		
	CAPRI S.	F-5	P-5		
	NEO-DAKKI	F-5	P-5		
FTH-7	CAPRI	F-5	P-5		
	CAPRI S.	F-5	P-5		
	NEO-DAKKI	F-5	P-5		
	XCODE	F-19			
<b>GERA</b>	ORIGINAL GERA WS / WS XP / PLUS	XCODE	F-13W		
<b>GERDA</b>	GDA-1P	CAPRI	F-1	P-1	
		CAPRI S.	F-1	P-1	
		NEO-DAKKI	F-1	P-1	
<b>GIOBERT</b>	GIOB-3P	CAPRI	F-6	P-6	
		CAPRI S.	F-6	P-6	
		NEO-DAKKI	F-6	P-6	
		NEO-DAKKI	F-6		
<b>GODREJ</b>	GOD-1	CAPRI	F-1	P-1	
		CAPRI S.	F-1	P-1	
		NEO-DAKKI	F-1	P-1	
	GOD-2	CAPRI	F-1	P-1	
		CAPRI S.	F-1	P-1	
		NEO-DAKKI	F-1	P-1	
<b>G.M.</b>	GM-49DP	CAPRI	F-11	P-11	
		CAPRI S.	F-11	P-11	
		NEO-DAKKI	F-11	P-11	

# SEGURIDAD SECURITY

							
<b>HB</b>	HB-1	CAPRI	F-13	P-13			
		CAPRI S.	F-13	P-13			
		NEO-DAKKI	F-13	P-13			
<b>HONDA</b>	HOND-17P	CAPRI	F-11	P-11			
		CAPRI S.	F-11	P-11			
		NEO-DAKKI	F-11	P-11			
		XCODE	F-11W				
	TPO0 HOND-31P	CAPRI	F-11	P-11			
		CAPRI S.	F-11	P-11			
		NEO-DAKKI	F-11	P-11			
		XCODE	F-11W				
	<b>HTEC</b>	HTE-50	CAPRI	F-5	P-5		
			CAPRI S.	F-5	P-5		
NEO-DAKKI			F-5	P-5			
<b>HUF</b>	BM-1P	CAPRI	F-1	P-1			
		CAPRI S.	F-1	P-1			
		NEO-DAKKI	F-1	P-1			
	BM-4	CAPRI	F-11	P-11	AD-MJ		
		CAPRI S.	F-11	P-11	AD-MJ		
		NEO-DAKKI	F-11	P-11	AD-MJ		
	BM-5P	CAPRI	F-11	P-11	AD-MJ		
		CAPRI S.	F-11	P-11	AD-MJ		
		NEO-DAKKI	F-11	P-11	AD-MJ		
		XCODE	F-11W				
	BM-6P	CAPRI	F-11	P-11	AD-AUDI		
		CAPRI S.	F-11	P-11	AD-AUDI		
		NEO	F-11	P-11			
		DAKKI	F-11	P-11	AD-AUDI		
	XCODE	F-17W		AD-X06			
	BM-7P	CAPRI	F-33	P-33			
		CAPRI S.	F-33	P-33			
		NEO-DAKKI	F-33	P-33			
		XCODE	F-22				
	HU-2P	CAPRI	F-11	P-11			
CAPRI S.		F-11	P-11				
NEO-DAKKI		F-11	P-11				
XCODE		F-11W					
HU-2P-1	CAPRI	F-11	P-11				
	CAPRI S.	F-11	P-11				
	NEO-DAKKI	F-11	P-11				

						
<b>HUF</b>	HU-DHP	CAPRI	F-11	P-11		
		CAPRI S.	F-11	P-11		
		NEO-DAKKI	F-11	P-11		
		XCODE	F-11W			
HU-DHP-1	CAPRI	F-11	P-11			
	CAPRI S.	F-11	P-11			
	NEO-DAKKI	F-11	P-11			
	XCODE	F-11W				
HU-DHP2	CAPRI	F-11	P-11			
	CAPRI S.	F-11	P-11			
	NEO-DAKKI	F-11	P-11			
	XCODE	F-11W				
HU-DHP-3	CAPRI	F-11	P-11			
	CAPRI S.	F-11	P-11			
	NEO-DAKKI	F-11	P-11			
	XCODE	F-11W				
HU-DNP	CAPRI	F-11	P-11			
	CAPRI S.	F-11	P-11			
	NEO-DAKKI	F-11	P-11			
	XCODE	F-11W				
HU-HAAP	CAPRI	F-11	P-11	AD-AUDI		
	CAPRI S.	F-11	P-11	AD-AUDI		
	NEO	F-11	P-11			
	DAKKI	F-11	P-11	AD-AUDI		
XCODE	F-17W		AD-AU			
HU-HAAP1	CAPRI	F-11	P-11	AD-AUDI		
	CAPRI S.	F-11	P-11	AD-AUDI		
	NEO	F-11	P-11			
	DAKKI	F-11	P-11	AD-AUDI		
XCODE	F-17W		AD-AU			
HU-HCAP	CAPRI	F-11	P-11			
	CAPRI S.	F-11	P-11			
	NEO-DAKKI	F-11	P-11			
	XCODE	F-17W				
ME-2P	CAPRI	F-11	P-11	AD-MJ		
	CAPRI S.	F-11	P-11	AD-MJ		
	NEO - DAKKI	F-11	P-11	AD-MJ		
	XCODE	F-11W				
ME-3P	CAPRI	F-11	P-11	AD-MJ		
	CAPRI S.	F-11	P-11	AD-MJ		
	NEO - DAKKI	F-11	P-11	AD-MJ		







HUF		XCODE	F-11W		
ME-4P	CAPRI	F-11	P-11	AD-MM	
	CAPRI S.	F-11	P-11	AD-MM	
	NEO	F-11	P-11		
	DAKKI	F-11	P-11	AD-MM	
	XCODE	F-11W		AD-X04	
ME-5P	CAPRI	F-11	P-11	AD-MM	
	CAPRI S.	F-11	P-11	AD-MM	
	NEO	F-11	P-11		
	DAKKI	F-11	P-11	AD-MM	
	XCODE	F-11W		AD-X04	
ME-6P	CAPRI	F-11	P-11	AD-MM	
	CAPRI S.	F-11	P-11	AD-MM	
	NEO	F-11	P-11		
	DAKKI	F-11	P-11	AD-MM	
ME-7P	CAPRI	F-11	P-11	AD-MM	
	CAPRI S.	F-11	P-11	AD-MM	
	NEO	F-11	P-11		
	DAKKI	F-11	P-11	AD-MM	
	XCODE	F-11W		AD-X04	
ME-8P	CAPRI	F-11	P-11	AD-MM	
	CAPRI S.	F-11	P-11	AD-MM	
	NEO	F-11	P-11		
	DAKKI	F-11	P-11	AD-MM	
ME-10P	CAPRI	F-11	P-11	AD-MM	
	CAPRI S.	F-11	P-11	AD-MM	
	NEO	F-11	P-11		
	DAKKI	F-11	P-11	AD-MM	
	XCODE	F-11W		AD-X04	
ME-11P	CAPRI	F-11	P-11	AD-MM	
	CAPRI S.	F-11	P-11	AD-MM	
	NEO	F-11	P-11		
	DAKKI	F-11	P-11	AD-MM	
	XCODE	F-11W		AD-X04	
ME-12P	CAPRI	F-11	P-11	AD-MM	
	CAPRI S.	F-11	P-11	AD-MM	
	NEO	F-11	P-11		
	DAKKI	F-11	P-11	AD-MM	
	XCODE	F-11W		AD-X04	
OP-11C1	CAPRI	F-11	P-11		
	CAPRI S.	F-11	P-11		















HUF		NEO-DAKKI	F-11	P-11	
OP-11P1	CAPRI	F-11	P-11		
	CAPRI S.	F-11	P-11		
	NEO-DAKKI	F-11	P-11		
	XCODE	F-17W			
OP-WHP	NEO-DAKKI	F-11	P-11	AD-OP	
	CAPRI	F-11	P-11	AD-OP	
	CAPRI S.	F-11	P-11	AD-OP	
	XCODE	F-11W			
OP-WHC	NEO-DAKKI	F-11	P-11	AD-OP	
	CAPRI	F-11	P-11	AD-OP	
	CAPRI S.	F-11	P-11	AD-OP	
	XCODE	F-11W			
OP-WYP	CAPRI	F-11	P-11	AD-OP	
	CAPRI S.	F-11	P-11	AD-OP	
	NEO-DAKKI	F-11	P-11	AD-OP	
	XCODE	F-11W			
HYUNDAI	HY-18P	CAPRI	F-11	P-11	
		CAPRI S.	F-11	P-11	
		NEO-DAKKI	F-11	P-11	
HY-18P1C1	CAPRI	F-11	P-11		
	CAPRI S.	F-11	P-11		
	NEO-DAKKI	F-11	P-11		
HY-19P	CAPRI	F-11	P-11		
	CAPRI S.	F-11	P-11		
	NEO-DAKKI	F-11	P-11		
IFAM	IF-2	CAPRI	F-1	P-1	
		CAPRI S.	F-1	P-1	
		NEO-DAKKI	F-1	P-1	
		XCODE	F-5W		
IF-4	CAPRI	F-1	P-1		
	CAPRI S.	F-1	P-1		
	NEO-DAKKI	F-1	P-1		
	XCODE	F-5W			
IF-6	CAPRI	F-19	P-19		
	CAPRI S.	F-19	P-19		
	NEO-DAKKI	F-19	P-19		
	XCODE	F-19			
INCECA	INCE-1E	CAPRI	F-8	P-8	
		CAPRI S.	F-8	P-8	FIC-TUB
IR	IR-1P	CAPRI	F-1	P-1	









# SEGURIDAD SECURITY







					
IR	CAPRI S.	F-1	P-1		
	NEO-DAKKI	F-1	P-1		
ISEO	IS-10	NEO-DAKKI	F-1	P-1	
		CAPRI	F-1	P-1	
		CAPRI S.	F-1	P-1	
	IS-10P	NEO-DAKKI	F-1	P-1	
		CAPRI	F-1	P-1	
		CAPRI S.	F-1	P-1	
	IS-14D	CAPRI	F-1	P-1	
		CAPRI S.	F-1	P-1	
		NEO-DAKKI	F-1	P-1	
	IS-20	CAPRI	F-1	P-1	
		CAPRI S.	F-1	P-1	
		NEO-DAKKI	F-1	P-1	
	IS-6D	CAPRI	F-1	P-1	
		CAPRI S.	F-1	P-1	
NEO-DAKKI		F-1	P-1		
XCODE		F-1W			
ITO	ITO-2D	CAPRI	F-1	P-1	
		CAPRI S.	F-1	P-1	
		NEO-DAKKI	F-1	P-1	
		XCODE	F-1W		
JARDI	JAR-1E	CAPRI	F-14	P-14	AD-JAR1E
		CAPRI S.	F-14	P-14	AD-JAR1E
		NEO-DAKKI	F-14	P-14	AD-JAR1E
JIS	JIS-4P	CAPRI	F-11	P-11	AD-JIS
		CAPRI S.	F-11	P-11	AD-JIS
		NEO-DAKKI	F-11	P-11	AD-JIS
JPM	JPM-1E	CAPRI	F-8	P-8	
		CAPRI S.	F-8	P-8	FIC-TUB
	JPM-2E	CAPRI	F-8	P-8	
		CAPRI S.	F-8	P-8	FIC-TUB
KABA	KA-1	CAPRI	F-1	P-1	
		CAPRI S.	F-1	P-1	
		NEO-DAKKI	F-1	P-1	
		XCODE	F-27		
	KA-2	CAPRI	F-43	P-43	45°
		CAPRI	F-5	P-5	45°
		NEO-DAKKI	F-43	P-43	AD-45°
		NEO-DAKKI	F-5	P-5	AD-45°







					
KABA		CAPRI S.	F-43	P-43	AD-45°
		CAPRI S.	F-5	P-5	AD-45°
	KA-3	CAPRI	F-1	P-1	15°
		CAPRI S.	F-1	P-1	AD-15°
		NEO-DAKKI	F-1	P-1	AD-15°
		XCODE	F-27		AD+15
	KA-4	CAPRI	F-1	P-26	15°
		CAPRI	F-1	P-26	45°
		CAPRI S.	F-1	P-26	AD-15°
		CAPRI S.	F-1	P-26	AD-45°
		NEO-DAKKI	F-1	P-26	AD-15°
		NEO-DAKKI	F-1	P-26	AD-45°
	KA-5	CAPRI	F-4	P-4	
		CAPRI S.	F-4	P-4	
		NEO-DAKKI	F-4	P-4	
		XCODE	F-4		
	KA-6	CAPRI	F-1	P-1	
		CAPRI S.	F-1	P-1	
		NEO-DAKKI	F-1	P-1	
		XCODE	F-43		
	KA-7	CAPRI	F-1	P-1	
		CAPRI S.	F-1	P-1	
		NEO-DAKKI	F-1	P-1	
		XCODE	F-27		
	KA-8	CAPRI	F-1	P-1	
		CAPRI S.	F-1	P-1	
		NEO-DAKKI	F-1	P-1	
	KA-10	CAPRI	F-1	P-1	
CAPRI S.		F-1	P-1		
NEO-DAKKI		F-1	P-1		
XCODE		F-1W			
KA-11	CAPRI	F-1	P-1		
	CAPRI S.	F-1	P-1		
	NEO-DAKKI	F-1	P-1		
KIA	KI-7P	CAPRI	F-11	P-11	
		CAPRI S.	F-11	P-11	
		NEO-DAKKI	F-11	P-11	
		XCODE	F-11W		
	KI-9P	CAPRI	F-11	P-11	
		CAPRI S.	F-11	P-11	







						
<b>KIA</b>		NEO-DAKKI	F-11	P-11		
<b>KALE</b>	KAE-1	CAPRI	F-1	P-1		
		CAPRI S.	F-1	P-1		
		NEO-DAKKI	F-1	P-1		
		XCODE	F-5W			
	KAE-2	CAPRI	F-1	P-1		
		CAPRI S.	F-1	P-1		
		NEO-DAKKI	F-1	P-1		
	KAE-4	NEO-DAKKI	F-1	P-1		
		CAPRI	F-1	P-1		
		CAPRI S.	F-1	P-1		
	KAE-10D	CAPRI	F-1	P-1		
		CAPRI S.	F-1	P-1		
		NEO-DAKKI	F-1	P-1		
	KAE-11D	CAPRI	F-1	P-1		
		CAPRI S.	F-1	P-1		
		NEO-DAKKI	F-1	P-1		
		XCODE	F-13W			
	KAE-12D	CAPRI	F-13	P-13		
		CAPRI S.	F-13	P-13		
		NEO-DAKKI	F-13	P-13		
KAE-14	NEO-DAKKI	F-1	P-1			
	CAPRI	F-1	P-1			
	CAPRI S.	F-1	P-1			
<b>KESO</b>	KE-1	CAPRI	F-1	P-1	5°	
			F-1	P-1	ADPL-5°	
		CAPRI S.	F-1	P-1	ADPL-5°	
			F-1	P-1	AD-5°	
		NEO-DAKKI	F-1	P-1	AD-5°	
			F-1	P-1	ADPL-5°	
	XCODE		F-1W		AD-5°	
			F-1W		ADPL-5°	
		KE-3	CAPRI	F-5	P-5	
				F-S31	PS31	
			CAPRI S.	F-5	P-5	
				F-S31	PS31	
NEO-DAKKI	F-5	P-5				
	XCODE	F-5W				
KE-4	CAPRI	F-5	P-5			
		F-S31	PS31			







					
<b>KESO</b>	CAPRI S.	F-5	P-5		
		F-S31	PS31		
		NEO-DAKKI	F-5	P-5	
			F-S31	PS31	
	XCODE		F-5W		
			F-S31		
			F-S31		
	KE-5	CAPRI	F-1	P-1	
		CAPRI S.	F-1	P-1	
		NEO-DAKKI	F-1	P-1	
<b>LAPERCHE</b>	LAP-1E	CAPRI	F-8	P-8	
		CAPRI S.	F-8	P-8	FIC-TUB
	LAP-10D	CAPRI	F-13	P-13	
		CAPRI S.	F-13	P-13	
		NEO-DAKKI	F-13	P-13	
	LAP-11D	CAPRI	F-13	P-13	
		CAPRI S.	F-13	P-13	
		NEO-DAKKI	F-13	P-13	
	LAP-13P	CAPRI	F-13	P-13	
		CAPRI S.	F-13	P-13	
		NEO-DAKKI	F-13	P-13	
		XCODE	F-27		
	LAP-17P	CAPRI	F-13	P-13	
		CAPRI S.	F-13	P-13	
		NEO-DAKKI	F-13	P-13	
		XCODE	F-27		
	LAP-2E	CAPRI	F-8	P-8	
		CAPRI S.	F-8	P-8	FIC-TUB
LAP-4	CAPRI	F-13	P-13		
	CAPRI S.	F-13	P-13		
	NEO-DAKKI	F-13	P-13		
XCODE		F-5W			
		F-13	P-13		
		F-13	P-13		
LAP-8D	CAPRI	F-13	P-13		
	CAPRI S.	F-13	P-13		
	NEO-DAKKI	F-13	P-13		
LAP-20P	CAPRI	F-13	P-13		
	CAPRI S.	F-13	P-13		
	NEO-DAKKI	F-13	P-13		
	XCODE	F-27			
LAP-21P	CAPRI	F-13	P-13		
	CAPRI S.	F-13	P-13		
	NEO-DAKKI	F-13	P-13		

# SEGURIDAD SECURITY







						
<b>LAPERCHE</b>		XCODE	F-27			
	LAP-22P	CAPRI	F-13	P-13		
		CAPRI S.	F-13	P-13		
		NEO-DAKKI	F-13	P-13		
		XCODE	F-27			
	LAP-23P	CAPRI	F-13	P-13		
		CAPRI S.	F-13	P-13		
		NEO-DAKKI	F-13	P-13		
		XCODE	F-27			
	<b>LINCE</b>	LIN-13	CAPRI	F-5	P-5	
CAPRI S.			F-5	P-5		
NEO-DAKKI			F-5	P-5		
XCODE			F-5W			
LIN-19D		CAPRI	F-5	P-5		
		CAPRI S.	F-5	P-5		
		NEO-DAKKI	F-5	P-5		
		XCODE	F-5W			
LIN-21D		CAPRI	F-5	P-5		
		CAPRI S.	F-5	P-5		
		NEO-DAKKI	F-5	P-5		
ORIGINAL C-2/C-3/C-4		XCODE	F-5W		M7	
ORIGINAL C-5		XCODE	F-28W		M7	
LIN-26D		CAPRI	F-5	P-5		
		CAPRI S.	F-5	P-5		
		NEO-DAKKI	F-5	P-5		
		XCODE	F-5W			
<b>LYF</b>		LYF-1T	CAPRI	F-8	P-8	
			CAPRI S.	F-8	P-8	FIC-TUB
		LYF-2T	CAPRI	F-8	P-8	
	CAPRI S.		F-8	P-8	FIC-TUB	
<b>MASTER</b>	MAS-15P	CAPRI	F-6	P-6		
		CAPRI S.	F-6	P-6		
		NEO-DAKKI	F-6	P-6		
		XCODE	F-6			
<b>MASTER LOCK</b>	MASL-1	CAPRI	F-1	P-1		
		CAPRI S.	F-1	P-1		
		NEO-DAKKI	F-1	P-1		
<b>MAUER</b>	ORIGINAL NW4	CAPRI	F-13	P-13	10°	
		XCODE	F-13W		AD-X11	
<b>MAZDA</b>	MAZ-12P1	CAPRI	F-11	P-11		







					
<b>MAZDA</b>		CAPRI S.	F-11	P-11	
		NEO-DAKKI	F-11	P-11	
<b>MCM</b>	MCM-10	CAPRI	F-13	P-13	
		CAPRI S.	F-13	P-13	
		NEO-DAKKI	F-13	P-13	AD-MCM
		XCODE	F-13W		AD-X05
	MCM-16	CAPRI	F-13	P-13	
		CAPRI S.	F-13	P-13	
		NEO-DAKKI	F-13	P-13	
		XCODE	F-13W		
	MCM-21D	CAPRI	F-13	P-13	
		CAPRI S.	F-13	P-13	
		NEO-DAKKI	F-13	P-13	
	MCM-27	CAPRI	F-13	P-13	
		CAPRI S.	F-13	P-13	
		NEO-DAKKI	F-13	P-13	
	MCM-4SS	CAPRI	F-1	P-1	
CAPRI		F-B	PB		
CAPRI		F-C	PC		
CAPRI S.		F-1	P-1		
CAPRI S.		F-B	PB		
CAPRI S.		F-C	PC		
NEO-DAKKI		F-C	PC		
NEO-DAKKI		F-1	P-1		
NEO-DAKKI	F-B	PB			
<b>MERONI</b>	MER-1T	CAPRI	F-8	P-8	
		CAPRI S.	F-8	P-8	FIC-TUB
	MER-3T	CAPRI	F-8	P-8	
		CAPRI S.	F-8	P-8	FIC-TUB
<b>MG MONTI</b>	MGA-2	CAPRI	F-1	P-1	
		CAPRI S.	F-1	P-1	
		NEO-DAKKI	F-1	P-1	
<b>MLM</b>	MLM-4	CAPRI	F-1	P-1	
		CAPRI S.	F-1	P-1	
		NEO-DAKKI	F-1	P-1	
<b>MSM</b>	MSM-1	CAPRI	F-19	P-19	
		CAPRI S.	F-19	P-19	
		NEO-DAKKI	F-19	P-19	
<b>MUL.T.LOCK</b>	MUL-T2P	CAPRI	F-12A	P-12A	
		CAPRI	F-12B	P-12B	
		CAPRI S.	F-12A	P-12A	







					
<b>MULT.LOCK</b>		CAPRI S.	F-12B	P-12B	
		NEO-DAKKI	F-12A	P-12A	
	MUL-T2P	NEO-DAKKI	F-12B	P-12B	
		XCODE	F-12A		
		XCODE	F-12B	P-12X	
	MUL-T3P1	CAPRI	F-12A	P-12A	
		CAPRI	F-12B	P-12B	
		CAPRI S.	F-12A	P-12A	
		CAPRI S.	F-12B	P-12B	
		NEO-DAKKI	F-12A	P-12A	
		NEO-DAKKI	F-12B	P-12B	
		XCODE	F-12A		
		XCODE	F-12B	P-12X	
	MUL-T3PL	CAPRI	F-12A	P-12A	
		CAPRI	F-12B	P-12B	
		CAPRI S.	F-12A	P-12A	
		CAPRI S.	F-12B	P-12B	
		NEO-DAKKI	F-12A	P-12A	
		NEO-DAKKI	F-12B	P-12B	
	MUL-T4P	CAPRI	F-12A	P-12A	
		CAPRI	F-12B	P-12B	
		CAPRI S.	F-12A	P-12A	
		CAPRI S.	F-12B	P-12B	
		NEO-DAKKI	F-12A	P-12A	
		NEO-DAKKI	F-12B	P-12B	
		XCODE	F-12A		
		XCODE	F-12B	P-12X	
	MUL-T5P	CAPRI	F-12A	P-12A	
		CAPRI	F-12B	P-12B	
		CAPRI S.	F-12A	P-12A	
		CAPRI S.	F-12B	P-12B	
		NEO-DAKKI	F-12A	P-12A	
		NEO-DAKKI	F-12B	P-12B	
	MUL-T7P	CAPRI	F-12A	P-12A	
		CAPRI	F-12B	P-12B	
		CAPRI S.	F-12A	P-12A	
		CAPRI S.	F-12B	P-12B	
		NEO-DAKKI	F-12A	P-12A	
		NEO-DAKKI	F-12B	P-12B	
		XCODE	F-12A		
	XCODE	F-12B	P-12X		







						
<b>MULT.LOCK</b>	MUL-T8P-1	CAPRI	F-12A	P-12A		
		CAPRI	F-12B	P-12B		
		CAPRI S.	F-12A	P-12A		
		CAPRI S.	F-12B	P-12B		
		NEO-DAKKI	F-12A	P-12A		
		NEO-DAKKI	F-12B	P-12B		
	MUL-T9P-1	CAPRI	F-12A	P-12A		
		CAPRI	F-12B	P-12B		
		CAPRI S.	F-12A	P-12A		
		CAPRI S.	F-12B	P-12B		
		NEO-DAKKI	F-12A	P-12A		
		NEO-DAKKI	F-12B	P-12B		
	MUL-T10P	CAPRI	F-12A	P-12A		
		CAPRI	F-12B	P-12B		
		CAPRI S.	F-12A	P-12A		
		CAPRI S.	F-12B	P-12B		
		NEO-DAKKI	F-12A	P-12A		
		NEO-DAKKI	F-12B	P-12B		
		XCODE	F-12A			
		XCODE	F-12B	P-12X		
	MUL-T11P-1	CAPRI	F-12A	P-12A		
		CAPRI	F-12B	P-12B		
		CAPRI S.	F-12A	P-12A		
		CAPRI S.	F-12B	P-12B		
		NEO-DAKKI	F-12A	P-12A		
		NEO-DAKKI	F-12B	P-12B		
	MUL-T16P	CAPRI	F-12A	P-12A		
		CAPRI	F-12B	P-12B		
		CAPRI S.	F-12A	P-12A		
		CAPRI S.	F-12B	P-12B		
	MUL-T16P	NEO-DAKKI	F-12A	P-12A		
		NEO-DAKKI	F-12B	P-12B		
	ORIGINAL MT5	XCODE	F-12A			
		XCODE	F-12B	P-12X		
	ORIGINAL INTERACTIVE L / R	XCODE	F-12A			
		XCODE	F-12B	P-12X		
	<b>NEIMAN</b>	NE-40	CAPRI	F-11	P-11	
			CAPRI S.	F-11	P-11	
			NEO-DAKKI	F-11	P-11	
			XCODE	F-11W		
NE-40P-1		CAPRI	F-11	P-11		

# SEGURIDAD SECURITY

						
<b>NEIMAN</b>	CAPRI S.	F-11	P-11			
		NEO-DAKKI	F-11	P-11		
		XCODE	F-11W			
	NE-41P	CAPRI	F-11	P-11		
		CAPRI S.	F-11	P-11		
		NEO-DAKKI	F-11	P-11		
		XCODE	F-11W			
	NE-51P2	CAPRI	F-11	P-11		
		CAPRI S.	F-11	P-11		
		NEO-DAKKI	F-11	P-11		
		XCODE	F-11W			
	<b>OJMAR</b>	OJ-Q	CAPRI	F-5	P-5	
		CAPRI S.	F-5	P-5		
		NEO-DAKKI	F-5	P-5		
<b>OMEC</b>	OMC-3	CAPRI	F-1	P-1		
		CAPRI S.	F-1	P-1		
		NEO-DAKKI	F-1	P-1		
		XCODE	F-1W			
	OMC-4	CAPRI	F-1	P-1		
		CAPRI S.	F-1	P-1		
		NEO-DAKKI	F-1	P-1		
		XCODE	F-1W			
	OMC-7	CAPRI	F-1	P-1		
		CAPRI S.	F-1	P-1		
		NEO-DAKKI	F-1	P-1		
	<b>P&amp;C I.</b>	PCI-1T	CAPRI	F-8	P-8	
CAPRI S.			F-8	P-8	FIC-TUB	
<b>P.C.</b>	PC-1T	CAPRI	F-8	P-8		
		CAPRI S.	F-8	P-8	FIC-TUB	
	PC-3TP	CAPRI	F-8	P-8		
		CAPRI S.	F-8	P-8	FIC-TUB	
<b>PENZMASH</b>	PEN-2	CAPRI	F-1	P-1		
		CAPRI S.	F-1	P-1		
		NEO-DAKKI	F-1	P-1		
<b>PFAFFENHAIN</b>	PFA-13D	CAPRI	F-34	P-34	AD-PFA	
		CAPRI S.	F-34	P-34	AD-PFA	
		NEO-DAKKI	F-34	P-34	AD-PFA	
	PFA-14D	CAPRI	F-34	P-34	AD-PFA	
		CAPRI S.	F-34	P-34	AD-PFA	
		NEO-DAKKI	F-34	P-34	AD-PFA	
	PFA-15D	CAPRI	F-34	P-34	AD-PFA	







						
<b>PFAFFENHAIN</b>	CAPRI S.	F-34	P-34		AD-PFA	
		NEO-DAKKI	F-34	P-34	AD-PFA	
	PFA-16D	CAPRI	F-34	P-34		AD-PFA
		CAPRI S.	F-34	P-34		AD-PFA
		NEO-DAKKI	F-34	P-34		AD-PFA
	ORIGINAL BRAVUS	CAPRI	F-40	P-40		AD-BR
		CAPRI S.	F-40	P-40		AD-BR
		NEO-DAKKI	F-40	P-40		AD-BR
		XCODE	F-40W			AD-BR
	<b>PICARD</b>	PIC-1E	CAPRI	F-8	P-8	
CAPRI S.			F-8	P-8	FIC-TUB	
PIC-8D		CAPRI	F-1	P-1		
	NEO-DAKKI	F-1	P-1			
	CAPRI S.	F-1	P-1			
<b>POLLUX</b>	POL-3TEC	CAPRI	F-8	P-8		
		CAPRI S.	F-8	P-8	FIC-TUB	
	POL-4E	CAPRI	F-8	P-8		
		CAPRI S.	F-8	P-8	FIC-TUB	
	POL-5TEC	CAPRI	F-8	P-8		
	CAPRI S.	F-8	P-8	FIC-TUB		
<b>POTENT</b>	PTN-1D	CAPRI	F-19	P-19		
		CAPRI S.	F-19	P-19		
		NEO-DAKKI	F-19	P-19		
		XCODE	F-19			
	PTN-2D	CAPRI	F-19	P-19		
		CAPRI S.	F-19	P-19		
NEO-DAKKI		F-19	P-19			
<b>ROSSETTI</b>	ROSE-1	CAPRI	F-1	P-1		
		CAPRI S.	F-1	P-1		
		NEO-DAKKI	F-1	P-1		
<b>SAAB</b>	SAA-1P1	CAPRI	F-11	P-11		
		CAPRI S.	F-11	P-11		
		NEO-DAKKI	F-11	P-11		
		XCODE	F-11W			
<b>SEA</b>	SEA-1	CAPRI	F-1	P-1		
		CAPRI	F-3	P-3		
		CAPRI S.	F-1	P-1		
		CAPRI S.	F-3	P-3		
		NEO-DAKKI	F-1	P-1		
		NEO-DAKKI	F-3	P-3		
	SEA-2	CAPRI	F-1	P-1		







						
<b>SEA</b>		<i>CAPRI</i>	<i>F-3</i>	<i>P-3</i>		
		<i>CAPRI S.</i>	<i>F-1</i>	<i>P-1</i>		
		<i>CAPRI S.</i>	<i>F-3</i>	<i>P-3</i>		
		<i>NEO-DAKKI</i>	<i>F-1</i>	<i>P-1</i>		
		<i>NEO-DAKKI</i>	<i>F-3</i>	<i>P-3</i>		
<b>SECUREMME</b>	<i>SEC-1</i>	<i>CAPRI</i>	<i>F-23</i>	<i>P-23</i>		
		<i>CAPRI S.</i>	<i>F-23</i>	<i>P-23</i>		
		<i>NEO-DAKKI</i>	<i>F-23</i>	<i>P-23</i>		
		<i>XCODE</i>	<i>F-23W</i>			
	<i>SEC-2</i>	<i>CAPRI</i>	<i>F-19</i>	<i>P-19</i>		
		<i>CAPRI S.</i>	<i>F-19</i>	<i>P-19</i>		
		<i>NEO-DAKKI</i>	<i>F-19</i>	<i>P-19</i>		
		<i>XCODE</i>	<i>F-19</i>			
	<i>SEC-3</i>	<i>CAPRI</i>	<i>F-19</i>	<i>P-19</i>		
		<i>CAPRI S.</i>	<i>F-19</i>	<i>P-19</i>		
		<i>NEO-DAKKI</i>	<i>F-19</i>	<i>P-19</i>		
	<b>SECURITAL</b>	<i>SCR-1</i>	<i>CAPRI</i>	<i>F-1</i>	<i>P-1</i>	
<i>CAPRI S.</i>			<i>F-1</i>	<i>P-1</i>		
<i>NEO-DAKKI</i>			<i>F-1</i>	<i>P-1</i>		
<b>SERRALLER</b>	<i>SER-1T</i>	<i>CAPRI</i>	<i>F-8</i>	<i>P-8</i>		
		<i>CAPRI S.</i>	<i>F-8</i>	<i>P-8</i>	<i>FIC-TUB</i>	
	<i>SER-3D</i>	<i>CAPRI</i>	<i>F-1</i>	<i>P-1</i>		
		<i>CAPRI S.</i>	<i>F-1</i>	<i>P-1</i>		
		<i>NEO-DAKKI</i>	<i>F-1</i>	<i>P-1</i>		
<i>XCODE</i>	<i>F-1W</i>					
<b>SIDESE</b>	<i>SID-1</i>	<i>CAPRI</i>	<i>F-8</i>	<i>P-8</i>		
		<i>CAPRI S.</i>	<i>F-8</i>	<i>P-8</i>	<i>FIC-TUB</i>	
	<i>SID-2</i>	<i>CAPRI</i>	<i>F-8</i>	<i>P-8</i>		
		<i>CAPRI S.</i>	<i>F-8</i>	<i>P-8</i>	<i>FIC-TUB</i>	
<b>SMART</b>	<i>SMR-1P</i>	<i>CAPRI</i>	<i>F-11</i>	<i>P-11</i>		
		<i>CAPRI S.</i>	<i>F-11</i>	<i>P-11</i>		
		<i>NEO-DAKKI</i>	<i>F-11</i>	<i>P-11</i>		
<b>SPIDER</b>	<i>SPI-1</i>	<i>CAPRI</i>	<i>F-1</i>	<i>P-1</i>		
		<i>CAPRI S.</i>	<i>F-1</i>	<i>P-1</i>		
		<i>NEO-DAKKI</i>	<i>F-1</i>	<i>P-1</i>		
	<i>SPI-1D</i>	<i>CAPRI S.</i>	<i>F-1</i>	<i>P-1</i>		
		<i>NEO-DAKKI</i>	<i>F-1</i>	<i>P-1</i>		
<i>CAPRI</i>	<i>F-1</i>	<i>P-1</i>				
<i>XCODE</i>	<i>F-5W</i>					
<b>STS</b>	<i>STS-35</i>	<i>CAPRI</i>	<i>F-1</i>	<i>P-1</i>		
		<i>CAPRI S.</i>	<i>F-1</i>	<i>P-1</i>		

						
<b>STS</b>		<i>NEO-DAKKI</i>	<i>F-1</i>	<i>P-1</i>		
		<i>XCODE</i>	<i>F-1W</i>			
<i>STS-36</i>	<i>CAPRI</i>	<i>F-1</i>	<i>P-1</i>			
	<i>CAPRI S.</i>	<i>F-1</i>	<i>P-1</i>			
<i>STS-36</i>	<i>NEO-DAKKI</i>	<i>F-1</i>	<i>P-1</i>			
<i>STS-37</i>	<i>CAPRI</i>	<i>F-1</i>	<i>P-1</i>			
	<i>CAPRI S.</i>	<i>F-1</i>	<i>P-1</i>			
	<i>NEO-DAKKI</i>	<i>F-1</i>	<i>P-1</i>			
<i>STS-38</i>	<i>CAPRI</i>	<i>F-1</i>	<i>P-1</i>			
	<i>CAPRI S.</i>	<i>F-1</i>	<i>P-1</i>			
	<i>NEO-DAKKI</i>	<i>F-1</i>	<i>P-1</i>			
<i>STS-B1</i>	<i>CAPRI</i>	<i>F-1</i>	<i>P-1</i>			
	<i>CAPRI S.</i>	<i>F-1</i>	<i>P-1</i>			
	<i>NEO-DAKKI</i>	<i>F-1</i>	<i>P-1</i>			
<i>STS-T14</i>	<i>CAPRI</i>	<i>F-5</i>	<i>P-5</i>			
	<i>CAPRI S.</i>	<i>F-5</i>	<i>P-5</i>			
	<i>NEO-DAKKI</i>	<i>F-5</i>	<i>P-5</i>			
<i>XCODE</i>	<i>F-5W</i>					
<i>STS-TV3</i>	<i>CAPRI</i>	<i>F-1</i>	<i>P-1</i>			
	<i>CAPRI S.</i>	<i>F-1</i>	<i>P-1</i>			
	<i>NEO-DAKKI</i>	<i>F-1</i>	<i>P-1</i>			
<i>XCODE</i>	<i>F-1W</i>					
<i>STS-TV5</i>	<i>CAPRI</i>	<i>F-1</i>	<i>P-1</i>			
	<i>CAPRI S.</i>	<i>F-1</i>	<i>P-1</i>			
	<i>NEO-DAKKI</i>	<i>F-1</i>	<i>P-1</i>			
<i>XCODE</i>	<i>F-1W</i>					
<i>STS-TV8</i>	<i>CAPRI</i>	<i>F-1</i>	<i>P-1</i>			
	<i>CAPRI S.</i>	<i>F-1</i>	<i>P-1</i>			
	<i>NEO-DAKKI</i>	<i>F-1</i>	<i>P-1</i>			
<i>XCODE</i>	<i>F-1W</i>					
<i>STS-TV9</i>	<i>CAPRI</i>	<i>F-1</i>	<i>P-1</i>			
	<i>CAPRI S.</i>	<i>F-1</i>	<i>P-1</i>			
	<i>NEO-DAKKI</i>	<i>F-1</i>	<i>P-1</i>			
<i>XCODE</i>	<i>F-1W</i>					
<i>STS-X5</i>	<i>CAPRI</i>	<i>F-5</i>	<i>P-5</i>	<i>AD-STS</i>		
	<i>CAPRI S.</i>	<i>F-5</i>	<i>P-5</i>	<i>AD-STS</i>		
	<i>NEO-DAKKI</i>	<i>F-5</i>	<i>P-5</i>	<i>AD-STS</i>		
	<i>XCODE</i>	<i>F-5W</i>		<i>AD-STS</i>		
<i>STS-X6</i>	<i>CAPRI</i>	<i>F-5</i>	<i>P-5</i>	<i>AD-STS</i>		
	<i>CAPRI S.</i>	<i>F-5</i>	<i>P-5</i>	<i>AD-STS</i>		
	<i>NEO-DAKKI</i>	<i>F-5</i>	<i>P-5</i>	<i>AD-STS</i>		







# SEGURIDAD SECURITY







						
<b>STS</b>		XCODE	F-5W			AD-ST5
	ORIGINAL CS7 / CSP-7 / CS8	XCODE	F-5W			
	ORIGINAL ST15	XCODE	F-23W			M5
	ORIGINAL ST8	XCODE	F-5W			
	ORIGINAL ST6	XCODE	F-23W			
<b>SUBARU</b>	SUB-2P	CAPRI	F-11	P-11		
		CAPRI S.	F-11	P-11		
		NEO-DAKKI	F-11	P-11		
		XCODE	F-11W			
<b>TARONI</b>	TRO-1	CAPRI	F-1	P-1		
		CAPRI S.	F-1	P-1		
		NEO-DAKKI	F-1	P-1		
		XCODE	F-1W			
	TRO-1D	CAPRI	F-1	P-1		
		CAPRI S.	F-1	P-1		
		NEO-DAKKI	F-1	P-1		
		XCODE	F-1W			
<b>TECON</b>	TC-1	CAPRI	F-5	P-5		
		CAPRI S.	F-5	P-5		
		NEO-DAKKI	F-5	P-5		
		XCODE	F-5W	P-5		
<b>TECSESA</b>	TEC-2	CAPRI	F-5	P-5		
		CAPRI S.	F-5	P-5		
		NEO-DAKKI	F-5	P-5		
		XCODE	F-5W			
<b>TESA</b>	TE-T10	CAPRI	F-5	P-5		
		CAPRI S.	F-5	P-5		
		NEO-DAKKI	F-5	P-5		
		XCODE	F-5W			
	TE-T10D	CAPRI	F-5	P-5		
		CAPRI S.	F-5	P-5		
		NEO-DAKKI	F-5	P-5		
	TE-T11	CAPRI	F-5	P-5		
		CAPRI S.	F-5	P-5		
		NEO-DAKKI	F-5	P-5		
	TE-T12PLUS	CAPRI	F-5	P-5	AD-T12P	
		CAPRI S.	F-5	P-5	AD-T12P	
NEO-DAKKI		F-5	P-5	AD-T12P		







						
<b>TESA</b>	TE-T60	CAPRI	F-5	P-5		
		CAPRI S.	F-5	P-5		
		NEO-DAKKI	F-5	P-5		
		XCODE	F-5W			
	TE-T61	CAPRI	F-5	P-5		
		CAPRI S.	F-5	P-5		
		NEO-DAKKI	F-5	P-5		
	TE-T62	CAPRI	F-5	P-5		
		CAPRI S.	F-5	P-5		
		NEO-DAKKI	F-5	P-5		
		XCODE	F-5W			
	TE-T80	CAPRI	F-5	P-5		
CAPRI S.		F-5	P-5			
NEO-DAKKI		F-5	P-5			
XCODE		F-5W				
TE-T80EH	CAPRI	F-5	P-5			
	CAPRI S.	F-5	P-5			
	NEO-DAKKI	F-5	P-5			
	XCODE	F-5W				
TE-T80SC	CAPRI	F-5	P-5			
	CAPRI S.	F-5	P-5			
	NEO-DAKKI	F-5	P-5			
TE-T82	CAPRI	F-5	P-5			
	CAPRI S.	F-5	P-5			
	NEO-DAKKI	F-5	P-5			
	XCODE	F-5W				
<b>TSAG</b>	SAG-1T	CAPRI S.	F-8W	P-8	FIC-TUB	
		CAPRI	F-8W	P-8		
<b>TIBBE</b>	JAU-1P	CAPRI	F-22	P-22	AD-FO	
		CAPRI S.	F-22	P-22	AD-FO	
		NEO-DAKKI	F-22	P-22	AD-FO	
	JAU-2P	CAPRI	F-22	P-22	AD-FO	
		CAPRI S.	F-22	P-22	AD-FO	
		NEO-DAKKI	F-22	P-22	AD-FO	
<b>TITAN</b>	TIT-6	CAPRI	F-1	P-1		
		CAPRI S.	F-1	P-1		
		NEO-DAKKI	F-1	P-1		
		XCODE	F-6			
<b>TOVER</b>	TOV-2	CAPRI	F-1	P-1		
		CAPRI S.	F-1	P-1		
		NEO-DAKKI	F-1	P-1		





						
<b>TOVER</b>	TOV-4	CAPRI	F-1	P-1		
		CAPRI S.	F-1	P-1		
		NEO-DAKKI	F-1	P-1		
		XCODE	F-1W			
	TOV-5	CAPRI	F-1	P-1		
		CAPRI S.	F-1	P-1		
		NEO-DAKKI	F-1	P-1		
		XCODE	F-19			
	TOV-6	CAPRI	F-1	P-1		
		CAPRI S.	F-1	P-1		
		NEO-DAKKI	F-1	P-1		
		XCODE	F-6			
TOV-7	CAPRI	F-1	P-1			
	CAPRI S.	F-1	P-1			
	NEO-DAKKI	F-1	P-1			
<b>TOYOTA</b>	TOYO-18P	CAPRI	F-11	P-11		
		CAPRI S.	F-11	P-11		
		NEO-DAKKI	F-11	P-11		
		XCODE	F-11W			
	TOYO-30P	CAPRI	F-11	P-11		
		CAPRI S.	F-11	P-11		
		NEO-DAKKI	F-11	P-11		
	TOYO-30P	XCODE	F-11W			
	TOYO-30P1	CAPRI	F-11	P-11		
		CAPRI S.	F-11	P-11		
		NEO-DAKKI	F-11	P-11		
	TOYO-36P	CAPRI	F-11	P-11		
CAPRI S.		F-11	P-11			
NEO-DAKKI		F-11	P-11			
<b>TRELOCK</b>	TRL-4P	CAPRI	F-11	P-11		
		CAPRI S.	F-11	P-11		
		NEO-DAKKI	F-11	P-11		
<b>TRW-SIPEA</b>	FI-16P	CAPRI	F-33	P-33		
		CAPRI S.	F-33	P-33		
		NEO-DAKKI	F-33	P-33		
		XCODE	F-11W			
	SIP-4P3	CAPRI	F-11	P-11		
		CAPRI S.	F-11	P-11		
		NEO-DAKKI	F-11	P-11		
	SIP-4P4	CAPRI	F-11	P-11		
		CAPRI S.	F-11	P-11		

						
<b>TRW-SIPEA</b>		NEO-DAKKI	F-11	P-11		
		XCODE	F-11W			
<b>TSAG</b>	SAG-1T	CAPRI	F-8	P-8		
		CAPRI S.	F-8	P-8		FIC-TUB
<b>T-KEY</b>	TKY-2	NEO-DAKKI	F-1	P-1		
		CAPRI	F-1	P-1		
		CAPRI S.	F-1	P-1		
<b>UCEM</b>	UCEM-13D	CAPRI	F-13	P-13		
		CAPRI S.	F-13	P-13		
		NEO-DAKKI	F-13	P-13		
	UCEM-17D	CAPRI	F-13	P-13		
		CAPRI S.	F-13	P-13		
		NEO-DAKKI	F-13	P-13		
	UCEM-5D	CAPRI	F-14	P-14		
		CAPRI S.	F-14	P-14		
		NEO-DAKKI	F-14	P-14		
	UCEM-5I	CAPRI	F-14	P-14		
		CAPRI S.	F-14	P-14		
		NEO-DAKKI	F-14	P-14		
UCEM-8D	CAPRI	F-13	P-13			
	CAPRI S.	F-13	P-13			
	NEO-DAKKI	F-13	P-13			
UCEM-8DP	CAPRI	F-13	P-13			
	CAPRI S.	F-13	P-13			
	NEO-DAKKI	F-13	P-13			
<b>UNIVERSAL</b>	TX-2	CAPRI	F-1	P-1		
		CAPRI S.	F-1	P-1		
		NEO-DAKKI	F-1	P-1		
<b>URBIS</b>	URB-3D	CAPRI	F-1	P-1		
		CAPRI S.	F-1	P-1		
		NEO-DAKKI	F-1	P-1		
	URB-4D	CAPRI	F-1	P-1		
<b>VACHETTE</b>	VA-11	CAPRI	F-43	P-43		30°
		CAPRI S.	F-21	P-21		
	VA-15	CAPRI	F-21	P-21		
		NEO-DAKKI	F-21	P-21		

# SEGURIDAD SECURITY

					
<b>VACHETTE</b>	VA-17P	SARATOGA	FP-11		AD-NEVA
		TITAN	FP-11		AD-NEVA
		BERNA	FP-11		AD-NEVA
		VIENNA	FP-24		AD-NEVA
		EAUTO	FP-11		AD-NEVA
		ECCO	FP-11		AD-NEVA
		EPLUS	FP-11		AD-NEVA
	VA-25	CAPRI	F-21	P-21	15° 19°
		CAPRI S.	F-21	P-21	AD-VA58
	VA-25	NEO-DAKKI	F-21	P-21	AD-VA58
	VA-26	CAPRI	F-21	P-21	15° 19°
		CAPRI S.	F-21	P-21	AD-VA58
		NEO-DAKKI	F-21	P-21	AD-VA58
	VA-27	CAPRI	F-21	P-21	15° 19°
		CAPRI S.	F-21	P-21	AD-VA58
		NEO-DAKKI	F-21	P-21	AD-VA58
		XCODE	F-21		ADV-19
	VA-28	CAPRI	F-21	P-21	15° 19°
		CAPRI S.	F-21	P-21	AD-VA58
		NEO-DAKKI	F-21	P-21	AD-VA58
	VA-56	CAPRI	F-21	P-21	15° 19°
		CAPRI S.	F-21	P-21	AD-VA58
		NEO-DAKKI	F-21	P-21	AD-VA58
	VA-58	CAPRI	F-21	P-21	15° 19°
		CAPRI S.	F-21	P-21	AD-VA58
		NEO-DAKKI	F-21	P-21	AD-VA58
	VA-70	CAPRI	F-1	P-1	
		CAPRI S.	F-1	P-1	
NEO-DAKKI		F-1	P-1		
ORIGINAL VRX	CAPRI	F-1	P-1	AD-VAX	
	CAPRI S.	F-1	P-1	AD-VAX	
	NEO-DAKKI	F-1	P-1	AD-VAX	
<b>VALEO</b>	CIT-1P	CAPRI	F-11	P-11	
		CAPRI S.	F-11	P-11	
		NEO-DAKKI	F-11	P-11	
		XCODE	F-17W		
	PEU-1C-1	CAPRI	F-11	P-11	
		CAPRI S.	F-11	P-11	
		NEO-DAKKI	F-11	P-11	
	PEU-2C-1	CAPRI	F-11	P-11	
		CAPRI S.	F-11	P-11	

					
<b>VALEO</b>		NEO-DAKKI	F-11	P-11	
	PEU-1P	CAPRI	F-11	P-11	
		CAPRI S.	F-11	P-11	
		NEO-DAKKI	F-11	P-11	
<b>VIRO</b>	VI-14	CAPRI	F-13	P-13	
		CAPRI S.	F-13	P-13	
		NEO-DAKKI	F-13	P-13	
		XCODE	F-19		
<b>WANJIN</b>	WAN-1D	CAPRI	F-5	P-5	
		CAPRI S.	F-5	P-5	
		NEO-DAKKI	F-5	P-5	
<b>WILKA</b>	WIL-22	CAPRI	F-1	P-1	
		CAPRI S.	F-1	P-1	
		NEO-DAKKI	F-1	P-1	
		XCODE	F-1W		
	CARAT P3	CAPRI	F-1	P-1	CP-177
CAPRI S.		F-1	P-1	CP-177	
NEO-DAKKI		F-1	P-1	CP-177	
XCODE		F-1W		AD-X07	
<b>WINKHAUS</b>	WIN-1D	CAPRI	F-15	P-15	
		CAPRI S.	F-15	P-15	P-WIN
		NEO-DAKKI	F-15	P-15	P-WIN
	WIN-1I	CAPRI	F-15	P-15	
		CAPRI S.	F-15	P-15	P-WIN
		NEO-DAKKI	F-15	P-15	P-WIN
	WIN-2D	CAPRI	F-15	P-15	
		CAPRI S.	F-15	P-15	P-WIN
		NEO-DAKKI	F-15	P-15	P-WIN
	WIN-3D	CAPRI	F-15	P-15	
		CAPRI S.	F-15	P-15	P-WIN
		NEO-DAKKI	F-15	P-15	P-WIN
	WIN-4D	CAPRI	F-15	P-15	
		CAPRI S.	F-15	P-15	P-WIN
		NEO-DAKKI	F-15	P-15	P-WIN
	ORIGINAL X-TRA	XCODE	F-13W		M8
XCODE		F-13W		AD-X09	
<b>WT</b>	WT-1	CAPRI	F-33	P-33	
		CAPRI S.	F-33	P-33	
		NEO-DAKKI	F-33	P-33	
<b>YALE</b>	YA-23	CAPRI	F-11	P-11	AD-JIS
		CAPRI S.	F-11	P-11	AD-JIS

®	JMA					
<b>YALE</b>		<i>NEO-DAKKI</i>	<i>F-11</i>	<i>P-11</i>	<i>AD-JIS</i>	
	<i>YA-81</i>	<i>CAPRI</i>	<i>F-19</i>	<i>P-19</i>		
		<i>CAPRI S.</i>	<i>F-19</i>	<i>P-19</i>		
		<i>NEO-DAKKI</i>	<i>F-19</i>	<i>P-19</i>		
		<i>XCODE</i>	<i>F-19</i>	<i>P-19</i>		
	<i>YA-280D</i>	<i>CAPRI</i>	<i>F-5</i>	<i>P-5</i>		
		<i>CAPRI S.</i>	<i>F-5</i>	<i>P-5</i>		
		<i>NEO-DAKKI</i>	<i>F-5</i>	<i>P-5</i>		
	<b>YARDENI</b>	<i>YAR-1</i>	<i>CAPRI</i>	<i>F-13</i>	<i>P-13</i>	
			<i>CAPRI S.</i>	<i>F-13</i>	<i>P-13</i>	
<i>NEO-DAKKI</i>			<i>F-13</i>	<i>P-13</i>		
<i>XCODE</i>			<i>F-13W</i>			
<i>YAR-2</i>		<i>CAPRI</i>	<i>F-13</i>	<i>P-13</i>		
		<i>CAPRI S.</i>	<i>F-13</i>	<i>P-13</i>		
		<i>NEO-DAKKI</i>	<i>F-13</i>	<i>P-13</i>		
		<i>XCODE</i>	<i>F-13W</i>			
<i>YAR-3</i>		<i>CAPRI</i>	<i>F-13</i>	<i>P-13</i>		
		<i>CAPRI S.</i>	<i>F-13</i>	<i>P-13</i>		
		<i>NEO-DAKKI</i>	<i>F-13</i>	<i>P-13</i>		
		<i>XCODE</i>	<i>F-13W</i>			
<b>ZADI</b>		<i>ZA-10</i>	<i>CAPRI</i>	<i>F-1</i>	<i>P-1</i>	
			<i>CAPRI S.</i>	<i>F-1</i>	<i>P-1</i>	
			<i>NEO-DAKKI</i>	<i>F-1</i>	<i>P-1</i>	
			<i>XCODE</i>	<i>F-5W</i>		
	<i>ZA-14P</i>	<i>CAPRI</i>	<i>F-33</i>	<i>P-33</i>		
		<i>CAPRI S.</i>	<i>F-33</i>	<i>P-33</i>		
		<i>NEO-DAKKI</i>	<i>F-33</i>	<i>P-33</i>		
		<i>XCODE</i>	<i>F-22</i>			

## **LLAVES ORIGINALES**

JATORRIZKO GILTZAK

ORIGINAL KEYS

CLE ORIGINALES

ORIGINALSCHLÜSSEL



## **LLAVES DE SEGURIDAD**

SEGURITATEZKO GILTZAK

SECURITY KEYS











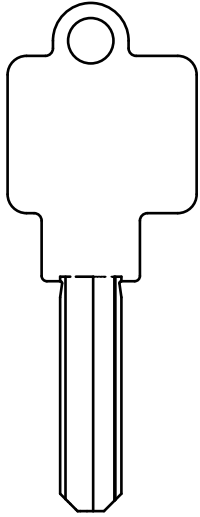

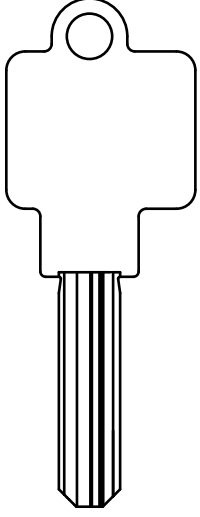

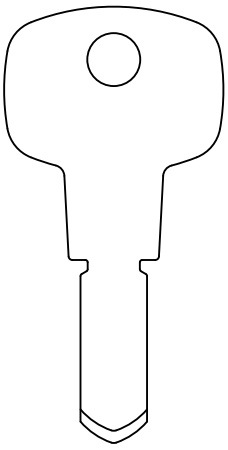

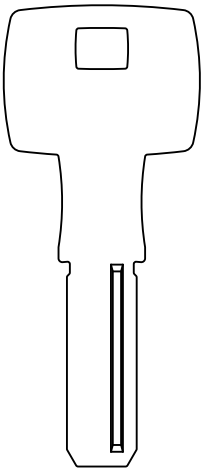

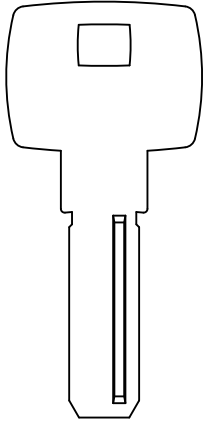

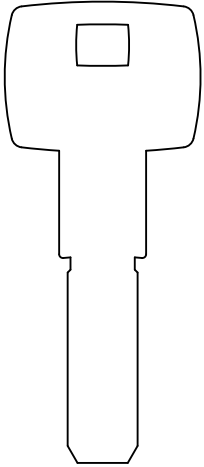

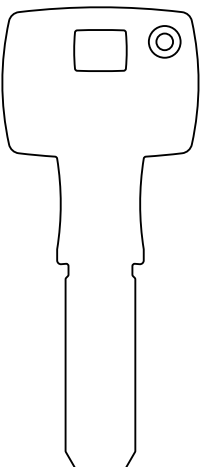
CLES DE SECURITE

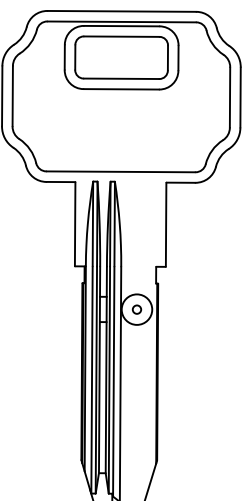
SICHERHEITSSCHLÜSSEL

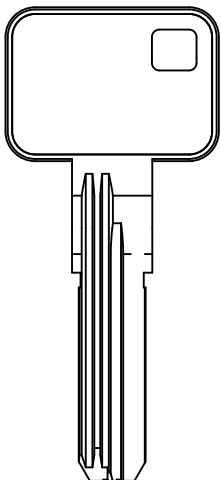
**THE KEY TO EXCELLENCE**

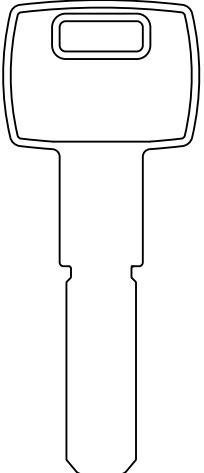
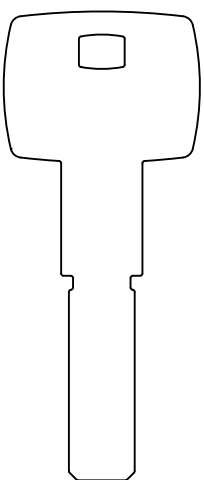
GLOBALLY UNLOCKING MILLIONS OF DOORS DAILY

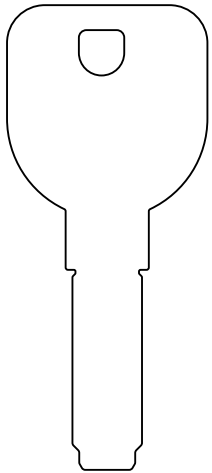
**LLAVES DE  
SEGURIDAD**  
SECURITY KEYS

BKS		CES	DOM
  <p>WS50 NW</p>	  <p>WS50 RA RK RZ</p>	  <p>WSM</p>	  <p>IX DAS</p>
DOM			LINCE
  <p>IX5 DAS</p>	  <p>IX6 KG</p>	  <p>IX6 SR</p>	  <p>C2 C3 C4</p>
LINCE		STS	VACHETTE
  <p>C5</p>	 <p>CX6</p>	  <p>ST15</p>	  <p>VRX ORIGINAL</p>



WINKHAUS

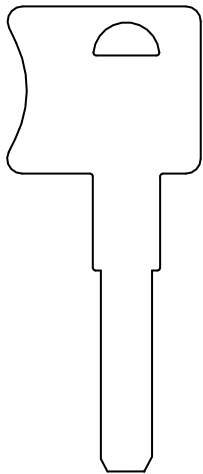

X-TRA ORIGINAL

LLAVES DE  
SEGURIDAD  
SECURITY KEYS

**JMA**<sup>®</sup>



Copyright by JMA Alejandro Altuna S.L.U. 2015

ATENCIÓN: Concerniente a las marcas y denominaciones comerciales ver nota en índice.  
ATTENTION: Concerning the marks and commercial denominations see note in index.  
ATTENTION: Concernant les marques et dénominations commerciales voir la note dans l'index.  
ACHTUNG: Beziehen auf die marke und handelsname sehen sie die notiz im index.

A31



# MÁQUINAS MECÁNICAS

MAKINA MEKANIKOAK  
MECHANICAL MACHINES  
MACHINES MECANIQUES  
MECHANISCHE MASCHINEN



**VIENNA - VIENNA S. - VIENNA X. - BERNA**  
**ECCO - ECCO AUTO - ECCO PLUS - SARATOGA - AVANTCODE**

## PARA LLAVES PLANAS

GILTZA LAUETARAKO  
FOR FLAT KEYS  
POUR CLE PLATES  
FÜR PLANE SCHLÜSSEL

**THE KEY TO EXCELLENCE**  
GLOBALLY UNLOCKING MILLIONS OF DOORS DAILY

## MÁQUINAS MACHINES

### VIENNA



La VIENNA es la máquina duplicadora de JMA para llaves planas para cilindro, vehículo y llaves cruciformes, diseñada para los profesionales de la duplicación. Nos trae un sistema innovador electrónico que hace que el ajuste de la máquina sea sencillo también para aquellas personas iniciadas en el duplicado, siguiendo unos pasos muy sencillos de ajuste, garantiza óptimos resultados de duplicado.

The VIENNA is the JMA flat key duplicating machine for cylinder locks, vehicle and cruciform keys, designed for key duplicating professionals. The Vienna has an innovative electronic system for easy adjustment of the machine as well as for those with long experience in duplicating, with a few simple steps for adjustment to guarantee optimal duplication results.

### VIENNA SMART



La VIENNA SMART es la nueva máquina duplicadora de JMA para llaves planas para cilindro, vehículo y llaves cruciformes, diseñada para los profesionales de la duplicación. Se combinan sencillez y versatilidad a la hora de duplicar llaves planas para cerraduras a cilindro y para vehículos, llaves cruciformes (en cruz) y especiales, gracias a su mordaza de 4 lados.

The VIENNA SMART is the new JMA flat key duplicating machine for cylinder locks, vehicle and cruciform keys, designed for key duplicating professionals. Combining simplicity and versatility in the duplication of flat keys for cylinder locks and for vehicles, cruciform keys (cross-shaped) and special keys, thanks to its 4-sided clamp.

### BERNA



BERNA es la máquina duplicadora compacta profesional en el que se combinan sencillez y versatilidad. Las tecnologías y materiales de última generación hacen de ella una máquina duplicadora resistente y precisa en el duplicado.

BERNA is the compact professional model of duplicating machine that combines simplicity and versatility. The latest generation techniques and materials make it a resistant and precise duplicating machine.

### VIENNA XCLUSIVE



La VIENNA XCLUSIVE es la máquina duplicadora de JMA para llaves planas para cilindro, vehículo y llaves cruciformes, diseñada para los profesionales de la duplicación. Se trata de la Vienna personalizado con un palpador inclinable para la reproducción de las llaves BRI-10, BRI-11, BRI-12 y mordaza de acero 4 caras amarre M-V-BD especial BRICARD.

VIENNA XCLUSIVE is the flat key duplicating machine for cylinder locks, vehicle and cruciform keys, designed for key duplicating professionals. Fitted with tiltable tracer for duplicating BRI-10, BRI-11, BRI-12 and steel 4-sided jaw M-V-BD special BRICARD.

## ECCO



Máquina semiautomática para el duplicado de llaves planas para cerraduras de cilindro y para vehículos, llaves cruciformes (en cruz) y especiales. LA ECCO es la expresión más sencilla de una máquina duplicadora sin perder la precisión en el duplicado. Su fresa con eje directo al motor hacen de ella la versión más económica en la familia de duplicadoras de llaves planas.

Semiautomatic machine for duplicating flat keys for cylinder locks and for vehicles, cruciform keys (cross-shaped) and special keys. The ECCO is the simplest expression of a duplicating machine without losing precision in the duplication. Its cutter directly fitted to the motor axle makes it the most economic model of the flat key duplicator machine family.

## ECCO AUTO



Máquina semiautomática para el duplicado de llaves planas para cerraduras de cilindro y para vehículos, llaves cruciformes (en cruz) y especiales. LA ECCO AUTOMATIC es la expresión más sencilla de una máquina duplicadora sin perder la precisión en el duplicado. Su fresa con eje directo al motor hacen de ella la versión más económica en la familia de duplicadoras de llaves planas.

Semiautomatic machine for duplicating flat keys for cylinder locks and for vehicles, cruciform keys (cross-shaped) and special keys. THE ECCO AUTOMATIC is the simplest expression of a duplicating machine without losing precision in the duplication. Its cutter directly fitted to the motor axle makes it the most economic model of the flat key duplicator machine family.

## ECCO PLUS



Máquina semiautomática para el duplicado de llaves planas para cerraduras de cilindro y para vehículos, llaves cruciformes (en cruz) y especiales. LA ECCO PLUS es la expresión más sencilla de una máquina duplicadora sin perder la precisión en el duplicado. Su fresa con eje directo al motor hacen de ella la versión más económica en la familia de duplicadoras de llaves planas.

Semiautomatic machine for duplicating flat keys for cylinder locks and for vehicles, cruciform keys (cross-shaped) and special keys. The ECCO PLUS is the simplest expression of a duplicating machine without losing precision in the duplication. Its cutter directly fitted to the motor axle makes it the most economic model of the flat key duplicator machine family.

## SARATOGA



Máquina duplicadora mixta de llaves planas, cruciformes, y por otro lado gorja de un paletón y doble paletón, frontales y especiales, pudiendo duplicar otros modelos de llaves con sus carros opcionales como regata, FORD®, ABLOY®. La Sataroga es una máquina robusta, sólida y fiable. Estas características y su versatilidad, hacen de ella una máquina indispensable en cualquier punto de duplicado.

Mixed duplicating machine for flat keys, cruciform keys, and also for single and double bit keys, frontal and special keys, being able to duplicate other models of keys with its optional carriages like channel, FORD® and ABLOY® keys. The Saratoga is a strong, solid and reliable machine. These characteristics and its versatility have made it a necessary machine for any duplicating point.

## AVANTCODE



Avantcode es la máquina electrónica de nueva generación más avanzada JMA para duplicar llaves de cilindro y vehículos, que permite el dentado de llaves de un lado y doble lado de mecanizado. Su velocidad y robustez garantiza la calidad óptima de corte al duplicar las llaves.

Avantcode is JMA's most advanced new generation electronic machine for duplicating cylinder and car keys that allows the bitting of keys with single or double sided machining. Its speed and strength guarantee the optimal quality of the cut when duplicating keys



## FRESAS CUTTERS

CODE	AXBXC	D	E	PALP.	PARA-FOR	MAT
FP-1	25x10x10	50	0		OREGON	HSS
FP-2W	40x6x10	35	0,1		VIRGINIA	W
FP-3	50x6x12	45	0,15		KIS	HSS
FP-4	53x6,3x12	45	0,1		KIS	HSS
FP-5	57x5x12,7	45	0,15		JMA	HSS
FP-6	60x5x12,7	42	0,1		SPRINT	HSS
FP-11	63x5x16	42	0,15		ECCO-ECCO PLUS-ECCO AUTO-MATIC	HSS
FP-12	63x5x16	40	0,1		TUCSON	HSS
FP-13	63x5x16-150D	42	0,1		DALLAS	HSS
FP-14	70x13x7	45	0		LINCE CE-2	HSS
FP-15	70x13x7-110	55	0		LINCE CM-1	HSS
FP-16	70x5,25x16	40	0,1		PROCEDURE	HSS
FP-16W	70x5,25x16	40	0,1		PROCEDURE-AVANTCODE	W
FP-24	80x5x16	42	0,15		BERNA- VIENNA-VIENNA S. DAKOTA EXTRA-SARATOGA-NEVADA-DENVER-TITAN-TITAN MASTER-	HSS
FP-25	80x5x16,30	42,3	0,15		LINCE CA-3	HSS
FP-32	63x2,4x16	45	0,5		ECCO-ECCO PLUS MEXICO - LATÓN	HSS
FP-41	80x8x16	50	1,2	P-81	C.CLAMP FB-489 SPECIAL	HSS
FP-42	80x8x16	45	0,85	P-82	C.CLAMP RU-488 SPECIAL	HSS
FP-43	80x8x16	45	1,55	P-83	C.CLAMP TE-476 SPECIAL	HSS
FP-44	80x8x16	52,5	0,15	P-84	C.CLAMP AB-744 SPECIAL	HSS
FP-46	80x8x16	45		P-86	C.CLAMP BA-570 SPECIAL	HSS
FP-49	80x8x16	45	0,4	P-89	C.CLAMP UNIVERSAL 90°	HSS
FP-50	80x8x16	50	0,4	P-90	C.CLAMP UNIVERSAL 100°	HSS

## CEPILLOS BRUSHES

CODE	F	PARA-FOR
C-1	60x10	BOSTON
C-2	75x10	CE-2
C-3	75x13	VIENNA S.DAKOTA-DAKOTA-EXTRA
C-4	80x10	DAKOTA ANTIGUA-NEVADA-KANSAS-DENVER
C-5	100x13	SARATOGA-YAKARTA
C-6	65x13	ECCO-PLUS-ECCO-BIT-BERNA
C-7	75x13 (Nylon)	PROCEDURE - SENNA - VIENNA

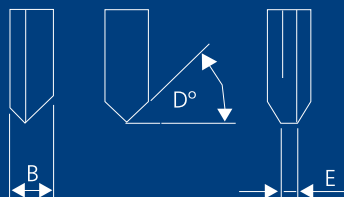
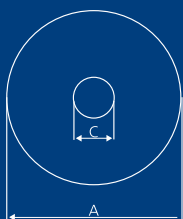

## SIMBOLOGÍA SYMBOLS

W

**Fresa de metal duro**  
Metal gogorreko fresa  
Hard metal cutters  
Fraise en métal dur  
Fräsen für Hartmetall

HSS

**Acero extra rápido**  
Altzairu estra azkarra  
High-speed steel  
Acier extra rapide  
Extraschneller Stahl



**Espesor**  
Lodiera  
Thickness  
Épaisseur  
Stärke



**Diámetro interior**  
Barnealdeko diametroa  
Internal diameter  
Alésage  
Innen-Durchmesser



**Ángulo de corte**  
Ebaketa-angelua  
Cutting angle  
Angle de coupe  
Schnittwinkel



**Parte llana ángulo de corte**  
Ebaketa-angeluko alde laua  
Flat part cutting angle  
Partie plate angle de coupe  
Flacher Teil, Schnittwinkel



**Diámetro externo**  
Kanpoaldeko diametroa  
External diameter  
Diamètre extérieur  
Aussen-Durchmesser





## FRESAS CUTTERS



## PALPADORES TRACERS

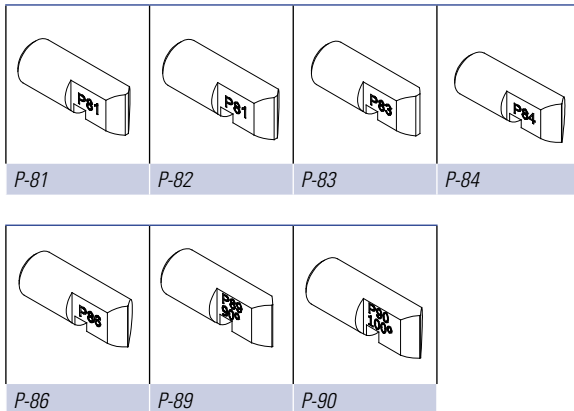

## CEPILLOS BRUSHES

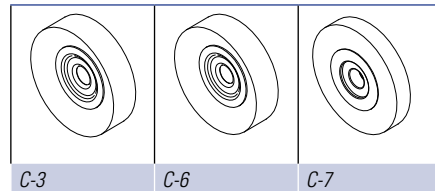

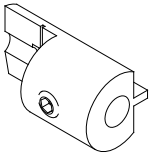
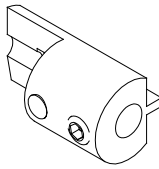
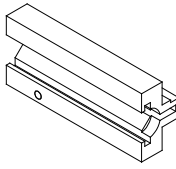
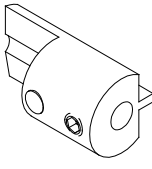
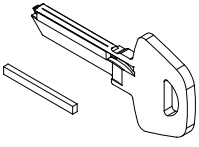
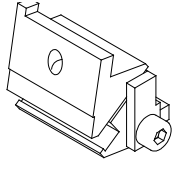
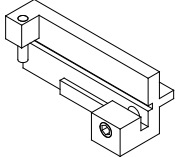
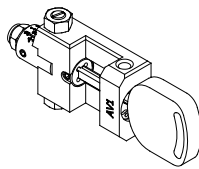
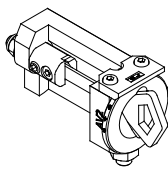
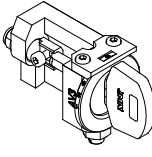
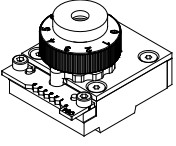
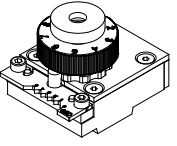

## ADAPTADORES ADAPTORS

					
AD-ALA-1X	AD-BLU-1X	AD-BRI-3X	AD-BUR-5X	AD-D12	AD-PO
					
AD-SIX	AV1	AV2	AV3	C.CLAMP AB-744	C.CLAMP AZ-507

ADAPTADOR	VIENNA	VIENNA SMART	BERNA	ECCO	ECCO PLUS	ECCO AUTO	SARATOGA	AVANTCODE	PROCEDURE
AD-ALA-1X	X	X	X	X	X		X		
AD-BLU-1X	X	X	X	X	X		X		
AD-BRI-3X	X	X	X	X	X		X		
AD-BUR-5X	X	X	X	X	X		X		
AD-D12	X	X	X	X	X	X	X	X	X
AD-PO	X	X	X	X	X		X		
AD-SIX	X	X	X	X	X		X	X	
AV1								X	
AV2								X	
AV3								X	
C.CLAMP AB-744		X	X				X		
C.CLAMP AZ-507		X	X				X		

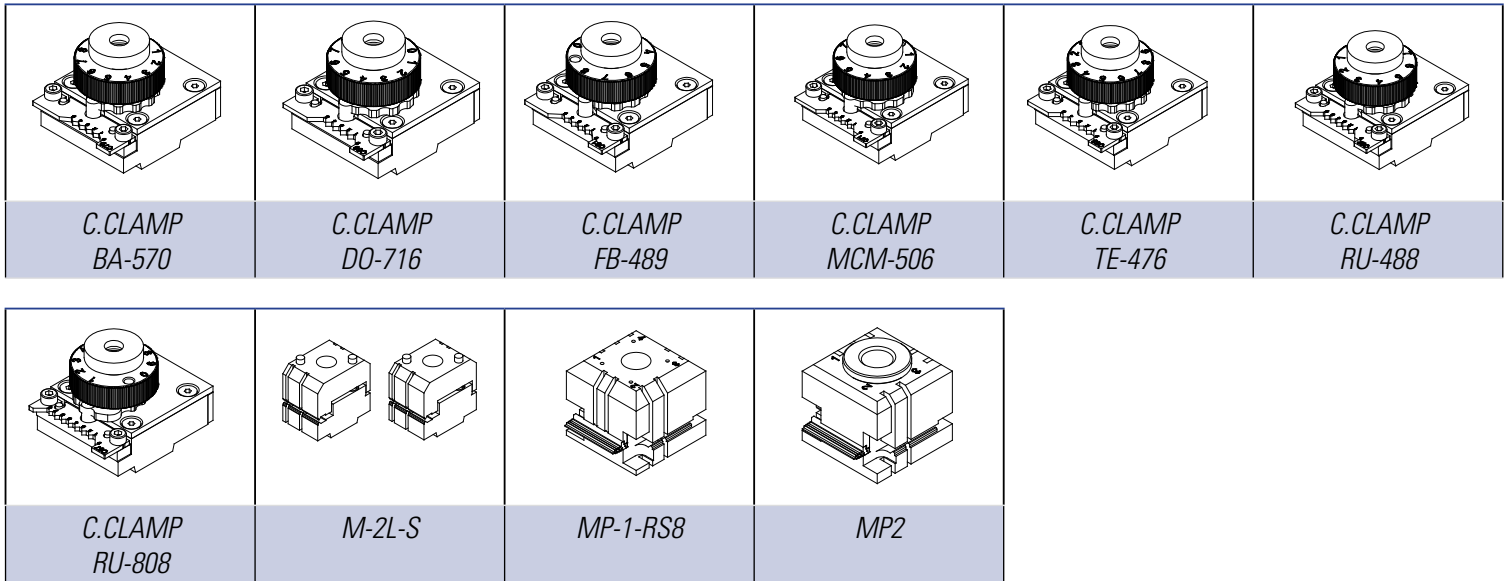

ADAPTADOR	VIENNA	VIENNA SMART	BERNA	ECCO	ECCO PLUS	ECCO AUTO	SARATOGA	AVANTCODE	PROCEDURE
C.CLAMP BA-570		X	X				X		
C.CLAMP DO-716		X	X				X		
C.CLAMP FB-489		X	X				X		
C.CLAMP MCM-506		X	X				X		
C.CLAMP RU-808		X	X				X		
C.CLAMP RU-488		X	X				X		
C.CLAMP TE-476		X	X				X		
M-2L-S				X	X				
MP-1-RS8								X	
MP2									X
M-SOF	X	X	X				X		
MW	X	X	X			X	X		



**MÁQUINA PARA LLAVES PLANA**  
GILTZA LAUETARAKO MAKINAK  
MACHINES FOR FLAT KEYS  
MACHINES POUR CLES PLATES  
MASCHINEN FÜR PLANE SCHLÜSSEL

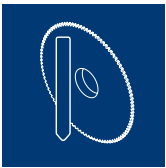

**FRESAS**  
FRESAK  
CUTTERS  
FRAISES  
FRÄSEN



**PALPADORES**  
HAZTAGAILUAK  
TRACERS  
PALPEURS  
FÜHLER



**ACCESORIOS**  
OSAGARRIAK  
ACCESSORIES  
ADAPTATEURS  
ZUBEHÖR

**VIENNA****VIENNA****VIENNA S.****VIENNA SMART****VIENNA X.****VIENNA XCLUSIVE****BERNA****BERNA****ECCO****ECCO****EPLUS****ECCO PLUS****EAUTO****ECCO AUTO****AVANTCODE****AVANTCODE****PROCEDURE****PROCEDURE**

# **FICHA ESPECIALISTA**

ESPEZIALISTAREN FITXA

SPECIALIST FILE

FICHE SPÉCIALISÉE

DATENBLATT FÜR FACHLEUTE

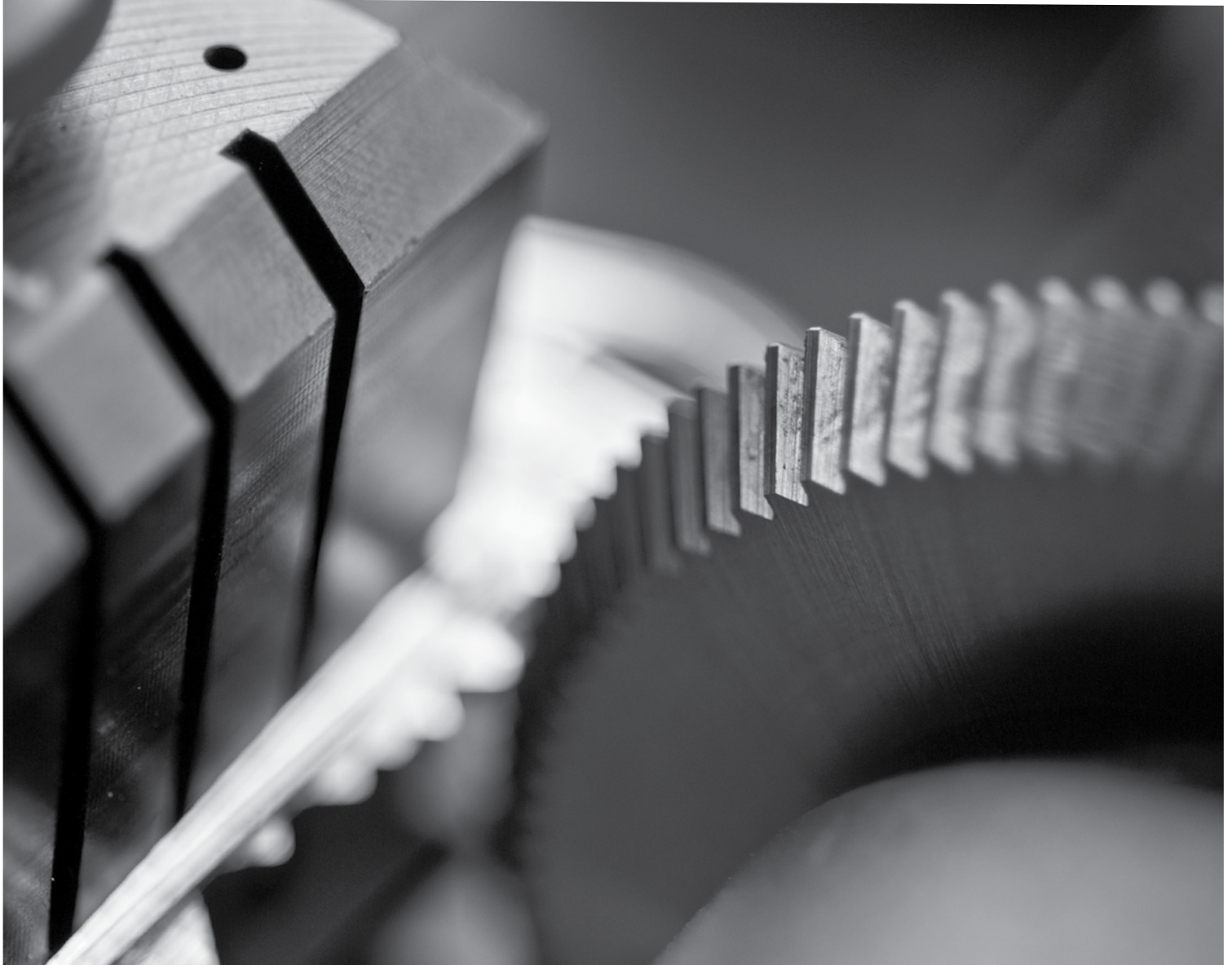

**VIENNA - VIENNA S. - VIENNA X. -BERNA**  
**ECCO - ECCOAUTO - ECCOPLUS - SARATOGA - AVANTCODE**

## **PARA LLAVES PLANAS**

GILTZA LAUETARAKO







FOR FLAT KEYS







POUR CLE PLATES

FÜR PLANE SCHLÜSSEL

**THE KEY TO EXCELLENCE**







GLOBALLY UNLOCKING MILLIONS OF DOORS DAILY







					
<b>ABLOY</b>	ABL-1	AVANTCODE	FP-27W		AV2
	ABL-2	AVANTCODE	FP-27W		AV2
	ABL-3	AVANTCODE	FP-27W		AV2
	ABL-4	AVANTCODE	FP-27W		AV2
<b>ABUS</b>	ABU-29P	AVANTCODE	FP-27W		AV3
	ORIGINAL XP/SP	SARATOGA	FP-44	P-84	C.CLAMP AB-744
		VIENNA	FP-44	P-84	C.CLAMP AB-744
		VIENNA S.	FP-44	P-84	C.CLAMP AB-744
		BERNA	FP-44	P-84	C.CLAMP AB-744
<b>ALA</b>	ALA-1X	SARATOGA			AD-ALA-1X
		VIENNA			AD-ALA-1X
		VIENNA S.			AD-ALA-1X
		BERNA			AD-ALA-1X
		ECCO			AD-ALA-1X
		EPLUS			AD-ALA-1X
		EAUTO			AD-ALA-1X
<b>ASSA / RUKO / TRIO-VING</b>	ORIGINAL D12	SARATOGA			AD-D12
		VIENNA			AD-D12
		VIENNA S.			AD-D12
		BERNA			AD-D12
		ECCO			AD-D12
		EPLUS			AD-D12
		EAUTO			AD-D12
<b>AZBE</b>	AZ-1D	SARATOGA	FP-49	P-89	C.CLAMP AZ-507
		VIENNA	FP-49	P-89	C.CLAMP AZ-507
		VIENNA S.	FP-49	P-89	C.CLAMP AZ-507
		BERNA	FP-49	P-89	C.CLAMP AZ-507
	AZ-1I	SARATOGA	FP-49	P-89	C.CLAMP AZ-507
		VIENNA	FP-49	P-89	C.CLAMP AZ-507
		VIENNA S.	FP-49	P-89	C.CLAMP AZ-507
		BERNA	FP-49	P-89	C.CLAMP AZ-507
		EAUTO			
	AZ-17D	SARATOGA	FP-49	P-89	C.CLAMP AZ-507
		VIENNA	FP-49	P-89	C.CLAMP AZ-507
		VIENNA S.	FP-49	P-89	C.CLAMP AZ-507
		BERNA	FP-49	P-89	C.CLAMP AZ-507
<b>BASI</b>	BA-1D	SARATOGA	FP-46	P-86	C.CLAMP BA-570

					
<b>BASI</b>		VIENNA	FP-46	P-86	C.CLAMP BA-570
		VIENNA S.	FP-46	P-86	C.CLAMP BA-570
		BERNA	FP-46	P-86	C.CLAMP BA-570
<b>BLUMA</b>	BLU-1X	SARATOGA			AD-BLU-1X
		VIENNA			AD-BLU-1X
		VIENNA S.			AD-BLU-1X
		BERNA			AD-BLU-1X
		ECCO			AD-BLU-1X
		EPLUS			AD-BLU-1X
		EAUTO			AD-BLU-1X
<b>BRICARD</b>	BRI-10	VIENNA EX.			
	BRI-12	VIENNA EX.			
	BRI-3X	SARATOGA			AD-BRI-3X
		VIENNA			AD-BRI-3X
		VIENNA EX.			
		VIENNA S.			AD-BRI-3X
		BERNA			AD-BRI-3X
	ECCO			AD-BRI-3X	
	EPLUS			AD-BRI-3X	
	EAUTO			AD-BRI-3X	
<b>BURG</b>	BUR-4X	SARATOGA			AD-BLU-1X
		VIENNA			AD-BLU-1X
		VIENNA S.			AD-BLU-1X
		BERNA			AD-BLU-1X
		ECCO			AD-BLU-1X
		EPLUS			AD-BLU-1X
		EAUTO			AD-BLU-1X
BUR-5X	SARATOGA			AD-BUR-5X	
	VIENNA			AD-BUR-5X	
	VIENNA S.			AD-BUR-5X	
	BERNA			AD-BUR-5X	
	ECCO			AD-BUR-5X	
	EPLUS			AD-BUR-5X	
	EAUTO			AD-BUR-5X	
<b>DOM</b>	ORIGINAL RS8	SARATOGA	FP-49	P-89	C.CLAMP DO-716
		VIENNA	FP-49	P-89	C.CLAMP DO-716
		VIENNA S.	FP-49	P-89	C.CLAMP DO-716
		BERNA	FP-49	P-89	C.CLAMP DO-716
					C.CLAMP DO-716
					MP-1-RS8











# PLANASFLAT

					
<b>DOM</b>		<i>PROCEDURE</i>			<i>MP2</i>
<b>FAB</b>	F-B-2D	SARATOGA	FP-50	P-90	C.CLAMP FB-489
		VIENNA	FP-50	P-90	C.CLAMP FB-489
		VIENNA S.	FP-50	P-90	C.CLAMP FB-489
		BERNA	FP-50	P-90	C.CLAMP FB-489
	F-B-2I	SARATOGA	FP-50	P-90	C.CLAMP FB-489
		VIENNA	FP-50	P-90	C.CLAMP FB-489
		VIENNA S.	FP-50	P-90	C.CLAMP FB-489
		BERNA	FP-50	P-90	C.CLAMP FB-489
	F-B-4	SARATOGA	FP-50	P-90	C.CLAMP FB-489
		VIENNA	FP-50	P-90	C.CLAMP FB-489
		VIENNA S.	FP-50	P-90	C.CLAMP FB-489
		BERNA	FP-50	P-90	C.CLAMP FB-489
	F-B-5	SARATOGA	FP-50	P-90	C.CLAMP FB-489
		VIENNA	FP-50	P-90	C.CLAMP FB-489
		VIENNA S.	FP-50	P-90	C.CLAMP FB-489
		BERNA	FP-50	P-90	C.CLAMP FB-489
	F-B-6	SARATOGA	FP-50	P-90	C.CLAMP FB-489
		VIENNA	FP-50	P-90	C.CLAMP FB-489
		VIENNA S.	FP-50	P-90	C.CLAMP FB-489
		BERNA	FP-50	P-90	C.CLAMP FB-489
	F-B-7	SARATOGA	FP-50	P-90	C.CLAMP FB-489
		VIENNA	FP-50	P-90	C.CLAMP FB-489
		VIENNA S.	FP-50	P-90	C.CLAMP FB-489
		BERNA	FP-50	P-90	C.CLAMP FB-489
	F-B-8	SARATOGA	FP-50	P-90	C.CLAMP FB-489
		VIENNA	FP-50	P-90	C.CLAMP FB-489
		VIENNA S.	FP-50	P-90	C.CLAMP FB-489
		BERNA	FP-50	P-90	C.CLAMP FB-489
	F-B-9	SARATOGA	FP-50	P-90	C.CLAMP FB-489
		VIENNA	FP-50	P-90	C.CLAMP FB-489
		VIENNA S.	FP-50	P-90	C.CLAMP FB-489
		BERNA	FP-50	P-90	C.CLAMP FB-489







					
<b>FAB</b>	F-B-10	SARATOGA	FP-50	P-90	C.CLAMP FB-489
		VIENNA	FP-50	P-90	C.CLAMP FB-489
		VIENNA S.	FP-50	P-90	C.CLAMP FB-489
		BERNA	FP-50	P-90	C.CLAMP FB-489
	F-B-11	SARATOGA	FP-50	P-90	C.CLAMP FB-489
		VIENNA	FP-50	P-90	C.CLAMP FB-489
		VIENNA S.	FP-50	P-90	C.CLAMP FB-489
		BERNA	FP-50	P-90	C.CLAMP FB-489
	F-B-12	SARATOGA	FP-50	P-90	C.CLAMP FB-489
		VIENNA	FP-50	P-90	C.CLAMP FB-489
		VIENNA S.	FP-50	P-90	C.CLAMP FB-489
		BERNA	FP-50	P-90	C.CLAMP FB-489
	F-B-13	SARATOGA	FP-50	P-90	C.CLAMP FB-489
		VIENNA	FP-50	P-90	C.CLAMP FB-489
		VIENNA S.	FP-50	P-90	C.CLAMP FB-489
		BERNA	FP-50	P-90	C.CLAMP FB-489
	F-B-14	SARATOGA	FP-50	P-90	C.CLAMP FB-489
		VIENNA	FP-50	P-90	C.CLAMP FB-489
		VIENNA S.	FP-50	P-90	C.CLAMP FB-489
		BERNA	FP-50	P-90	C.CLAMP FB-489
	F-B-15	SARATOGA	FP-50	P-90	C.CLAMP FB-489
		VIENNA	FP-50	P-90	C.CLAMP FB-489
		VIENNA S.	FP-50	P-90	C.CLAMP FB-489
		BERNA	FP-50	P-90	C.CLAMP FB-489
	F-B-16	SARATOGA	FP-50	P-90	C.CLAMP FB-489
		VIENNA	FP-50	P-90	C.CLAMP FB-489
		VIENNA S.	FP-50	P-90	C.CLAMP FB-489
		BERNA	FP-50	P-90	C.CLAMP FB-489
	F-B-17	SARATOGA	FP-50	P-90	C.CLAMP FB-489
		VIENNA	FP-50	P-90	C.CLAMP FB-489
		VIENNA S.	FP-50	P-90	C.CLAMP FB-489
		BERNA	FP-50	P-90	C.CLAMP FB-489
	F-B-18	SARATOGA	FP-50	P-90	C.CLAMP FB-489
		SARATOGA	FP-50	P-90	C.CLAMP FB-489







**THE KEY TO EXCELLENCE**  
GLOBALLY UNLOCKING MILLIONS OF DOORS DAILY

®	JMA					
<b>FAB</b>	VIENNA	FP-50	P-90	C.CLAMP FB-489		
	VIENNA S.	FP-50	P-90	C.CLAMP FB-489		
	BERNA	FP-50	P-90	C.CLAMP FB-489		
	F-B-26	SARATOGA	FP-50	P-90	C.CLAMP FB-489	
		VIENNA	FP-50	P-90	C.CLAMP FB-489	
		VIENNA S.	FP-50	P-90	C.CLAMP FB-489	
		BERNA	FP-50	P-90	C.CLAMP FB-489	
	F-B-27	SARATOGA	FP-50	P-90	C.CLAMP FB-489	
		VIENNA	FP-50	P-90	C.CLAMP FB-489	
		VIENNA S.	FP-50	P-90	C.CLAMP FB-489	
		BERNA	FP-50	P-90	C.CLAMP FB-489	
	F-B-28	SARATOGA	FP-50	P-90	C.CLAMP FB-489	
		VIENNA	FP-50	P-90	C.CLAMP FB-489	
		VIENNA S.	FP-50	P-90	C.CLAMP FB-489	
		BERNA	FP-50	P-90	C.CLAMP FB-489	
	F-B-29	SARATOGA	FP-50	P-90	C.CLAMP FB-489	
		VIENNA	FP-50	P-90	C.CLAMP FB-489	
		VIENNA S.	FP-50	P-90	C.CLAMP FB-489	
		BERNA	FP-50	P-90	C.CLAMP FB-489	
	F-B-30	SARATOGA	FP-50	P-90	C.CLAMP FB-489	
		VIENNA	FP-50	P-90	C.CLAMP FB-489	
		VIENNA S.	FP-50	P-90	C.CLAMP FB-489	
		BERNA	FP-50	P-90	C.CLAMP FB-489	
	F-B-32	SARATOGA	FP-50	P-90	C.CLAMP FB-489	
		VIENNA	FP-50	P-90	C.CLAMP FB-489	
		VIENNA S.	FP-50	P-90	C.CLAMP FB-489	
		BERNA	FP-50	P-90	C.CLAMP FB-489	
	<b>FIAM</b>	FM-1X	SARATOGA		AD-ALA-1X	
			VIENNA		AD-ALA-1X	
			VIENNA S.		AD-ALA-1X	
			BERNA		AD-ALA-1X	
			ECCO		AD-ALA-1X	
EPLUS				AD-ALA-1X		
EAUTO				AD-ALA-1X		

®	JMA					
<b>FORD</b>	FO-6P	AVANTCODE	FP-27W	AV1		
<b>GE GE</b>	GE-2 Pextra Flex	SARATOGA	FP-49	P-89	C.CLAMP RU-808	
		VIENNA	FP-49	P-89	C.CLAMP RU-808	
		VIENNA S.	FP-49	P-89	C.CLAMP RU-808	
<b>HUF</b>	PO-1P	SARATOGA			AD-PO	
		VIENNA			AD-PO	
		VIENNA S.			AD-PO	
		BERNA			AD-PO	
		ECCO			AD-PO	
	PO-2P	SARATOGA				AD-PO
		VIENNA				AD-PO
		VIENNA S.				AD-PO
		BERNA				AD-PO
		ECCO				AD-PO
<b>MCM</b>	MCM-13D	SARATOGA	FP-49	P-89	C.CLAMP MCM-506	
		VIENNA	FP-49	P-89	C.CLAMP MCM-506	
		VIENNA S.	FP-49	P-89	C.CLAMP MCM-506	
	MCM-18D	SARATOGA	FP-49	P-89		C.CLAMP MCM-506
		VIENNA	FP-49	P-89		C.CLAMP MCM-506
		VIENNA S.	FP-49	P-89		C.CLAMP MCM-506
		BERNA	FP-49	P-89		C.CLAMP MCM-506
	MCM-30	SARATOGA	FP-49	P-89		C.CLAMP MCM-506
		VIENNA	FP-49	P-89		C.CLAMP MCM-506
		VIENNA S.	FP-49	P-89		C.CLAMP MCM-506
<b>MIWA</b>	MIW-2	SARATOGA			MW	
		VIENNA			MW	
		VIENNA S.			MW	
		BERNA			MW	
		ECCO			MW	

# PLANASFLAT

						
<b>MIWA</b>		EPLUS			MW	
		EAUTO			MW	
	MIW-3	SARATOGA				MW
		VIENNA				MW
		VIENNA S.				MW
		BERNA				MW
		ECCO				MW
		EPLUS				MW
	MIW-4	EAUTO				MW
		SARATOGA				MW
		VIENNA				MW
		VIENNA S.				MW
		BERNA				MW
		ECCO				MW
	<b>MSV</b>	MSV-1	SARATOGA			M-SOF
			VIENNA			M-SOF
VIENNA S.					M-SOF	
BERNA					M-SOF	
ECCO					M-SOF	
EPLUS					M-SOF	
EAUTO					M-SOF	
MSV-2		SARATOGA				M-SOF
		VIENNA				M-SOF
		VIENNA S.				M-SOF
		BERNA				M-SOF
		ECCO				M-SOF
		EPLUS				M-SOF
		EAUTO				M-SOF
<b>RUKO</b>	RU-11D	SARATOGA	FP-49	P-89	C.CLAMP RU-488	
		VIENNA	FP-49	P-89	C.CLAMP RU-488	
		VIENNA S.	FP-49	P-89	C.CLAMP RU-488	
		BERNA	FP-49	P-89	C.CLAMP RU-488	
	RU-12D	SARATOGA	FP-49	P-89	C.CLAMP RU-488	
		VIENNA	FP-49	P-89	C.CLAMP RU-488	
		VIENNA S.	FP-49	P-89	C.CLAMP RU-488	
		BERNA	FP-49	P-89	C.CLAMP RU-488	

					
<b>RUKO</b>	RU-14D	SARATOGA	FP-49	P-89	C.CLAMP RU-488
		VIENNA	FP-49	P-89	C.CLAMP RU-488
		VIENNA S.	FP-49	P-89	C.CLAMP RU-488
		BERNA	FP-49	P-89	C.CLAMP RU-488
	RU-5D	SARATOGA	FP-49	P-89	C.CLAMP RU-488
		VIENNA	FP-49	P-89	C.CLAMP RU-488
		VIENNA S.	FP-49	P-89	C.CLAMP RU-488
		BERNA	FP-49	P-89	C.CLAMP RU-488
	RU-5I	SARATOGA	FP-49	P-89	C.CLAMP RU-488
		VIENNA	FP-49	P-89	C.CLAMP RU-488
		VIENNA S.	FP-49	P-89	C.CLAMP RU-488
		BERNA	FP-49	P-89	C.CLAMP RU-488
	RU-6I	SARATOGA	FP-49	P-89	C.CLAMP RU-488
		VIENNA	FP-49	P-89	C.CLAMP RU-488
		VIENNA S.	FP-49	P-89	C.CLAMP RU-488
		BERNA	FP-49	P-89	C.CLAMP RU-488
	RU-9D	SARATOGA	FP-49	P-89	C.CLAMP RU-488
		VIENNA	FP-49	P-89	C.CLAMP RU-488
		VIENNA S.	FP-49	P-89	C.CLAMP RU-488
		BERNA	FP-49	P-89	C.CLAMP RU-488
	RU-9I	SARATOGA	FP-49	P-89	C.CLAMP RU-488
		VIENNA	FP-49	P-89	C.CLAMP RU-488
		VIENNA S.	FP-49	P-89	C.CLAMP RU-488
		BERNA	FP-49	P-89	C.CLAMP RU-488
<b>SIMPLEX</b>	SIX-3P	SARATOGA			AD-SIX
		VIENNA			AD-SIX
		VIENNA S.			AD-SIX
		BERNA			AD-SIX
		ECCO			AD-SIX
		EPLUS			AD-SIX
<b>SOFER</b>	SOF-1	SARATOGA			M-SOF
		VIENNA			M-SOF
		VIENNA S.			M-SOF
		BERNA			M-SOF



<b>SOFER</b>		<i>ECCO</i>			<i>M-2L-S</i>
		<i>EPLUS</i>			<i>M-2L-S</i>
		<i>EAUTO</i>			<i>M-SOF</i>
	<i>SOF-2</i>	<i>SARATOGA</i>			<i>M-SOF</i>
		<i>VIENNA</i>			<i>M-SOF</i>
		<i>VIENNA S.</i>			<i>M-SOF</i>
		<i>BERNA</i>			<i>M-SOF</i>
		<i>ECCO</i>			<i>M-SOF</i>
		<i>EPLUS</i>			<i>M-2L-S</i>
		<i>EAUTO</i>			<i>M-SOF</i>
<b>TESA</b>	<i>TE-81</i>	<i>SARATOGA</i>	<i>FP-49</i>	<i>P-89</i>	<i>C.CLAMP</i> <i>TE-476</i>
		<i>VIENNA</i>	<i>FP-49</i>	<i>P-89</i>	<i>C.CLAMP</i> <i>TE-476</i>
		<i>VIENNA S.</i>	<i>FP-49</i>	<i>P-89</i>	<i>C.CLAMP</i> <i>TE-476</i>
		<i>BERNA</i>	<i>FP-49</i>	<i>P-89</i>	<i>C.CLAMP</i> <i>TE-476</i>
	<i>TE-23</i>	<i>SARATOGA</i>	<i>FP-49</i>	<i>P-89</i>	<i>C.CLAMP</i> <i>TE-476</i>
		<i>VIENNA</i>	<i>FP-49</i>	<i>P-89</i>	<i>C.CLAMP</i> <i>TE-476</i>
		<i>VIENNA S.</i>	<i>FP-49</i>	<i>P-89</i>	<i>C.CLAMP</i> <i>TE-476</i>
		<i>BERNA</i>	<i>FP-49</i>	<i>P-89</i>	<i>C.CLAMP</i> <i>TE-476</i>
	<i>TE-28</i>	<i>SARATOGA</i>	<i>FP-49</i>	<i>P-89</i>	<i>C.CLAMP</i> <i>TE-476</i>
		<i>VIENNA</i>	<i>FP-49</i>	<i>P-89</i>	<i>C.CLAMP</i> <i>TE-476</i>
		<i>VIENNA S.</i>	<i>FP-49</i>	<i>P-89</i>	<i>C.CLAMP</i> <i>TE-476</i>
		<i>BERNA</i>	<i>FP-49</i>	<i>P-89</i>	<i>C.CLAMP</i> <i>TE-476</i>

## **LLAVES ORIGINALES**

JATORRIZKO GILTZAK

ORIGINAL KEYS

CLE ORIGINALES

ORIGINALSCHLÜSSEL



## **LLAVES PLANAS**

GILTZA LAUAK

FLAT KEYS





CLES PLATES

PLANE SCHLÜSSEL

**THE KEY TO EXCELLENCE**

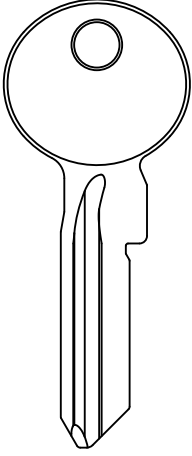
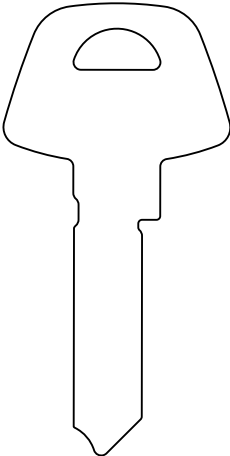
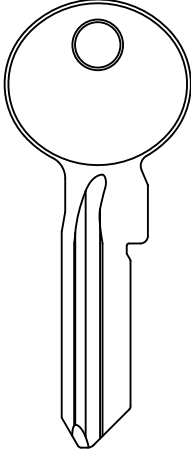
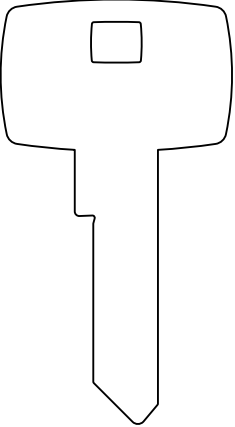
GLOBALLY UNLOCKING MILLIONS OF DOORS DAILY

**LLAVES  
PLANAS  
FLAT KEYS**

ABUS	ASSA	CISA	DOM-DORMA
			
 <b>ABUS XP</b>	 <b>D12</b>	 <b>CISA SP</b>	 <b>RS8 ORIGINAL</b>



# **MÁQUINAS MECÁNICAS**

MAKINA MEKANIKOAK  
MECHANICAL MACHINES  
MACHINES MECANIQUES  
MECHANISCHE MASCHINEN



**SENA - SARATOGA - TITAN BIT**  
**ECCOBIT - ECCORG - ECCOFORD - ECCOABLOY**

## **PARA LLAVES DE GORJA**

GORJA-GILTZETARAKO  
FOR BIT KEYS  
POUR CLES À GORGES  
FÜR DOPPELBARTSCHLÜSSEL

**THE KEY TO EXCELLENCE**  
GLOBALLY UNLOCKING MILLIONS OF DOORS DAILY





## MÁQUINAS MACHINES

### SENA



La SENA es la máquina duplicadora de JMA para llaves de gorja de simple y doble paletón, frontales y ranuras verticales, todo ello con un único carro. Dispone de un palpador (intercambiable) con ajuste micrométrico para su ajuste preciso. Utilizando una misma palanca se realiza los movimientos X e Y del carro, el cual está guiado por patines con rodillos.

The SENA is the JMA duplicating machine for bit keys with single and double bits, frontal and vertical channel keys, all on the same carriage. It has a tracer (interchangeable) with micrometric adjustment for precision using the same lever it makes X and Y movements of the carriage, which is guided by bearings on rollers.

### SARATOGA



Máquina duplicadora mixta de llaves planas, cruciformes, y por otro lado gorja de un paletón y doble paletón, frontales y especiales, pudiendo duplicar otro modelos de llaves con sus carros opcionales como regata, FORD®, ABLOY®. La Sataroga es una máquina robusta, sólida y fiable. Estas características y su versatilidad hacen de ella una máquina indispensable en cualquier punto de duplicado.

Mixed duplicating machine for flat keys, cruciform keys, and also for single and double bit keys, frontal and special keys, being able to duplicate other models of keys with its optional carriages like channel, FORD® and ABLOY® keys. The Saratoga is a strong, solid and reliable machine. These characteristics and its versatility have made it a necessary machine for any duplicating point.

### TITAN BIT



Máquina duplicadora de las llaves de gorja, de un paletón y doble paletón, frontales y especiales.

Bit-key duplicating machine for single and double bit keys, frontal and special keys.

## ECCO BIT



Máquina económica semiautomática para el duplicado de llaves de gorja, de un paletón y de doble paletón, frontales y especiales. La máquina se convierte en muy versátil gracias a sus diferentes carros opcionales que te permiten duplicar llaves tipo Abloy (ABL-E), Ford (FD-E) y regata (RG-E).

Semiautomatic versatile machine for bit keys, single and double bit keys, frontal and special keys. A versatile machine with different optional carriages to allow the duplication of Abloy keys (ABL-E), Ford keys (FD-E) and regata Keys (RG-E).

## ECCORG



Máquina semiautomática para llaves de gorja de tipo regata, dispone además de otros carros opcionales para llaves de gorja de un paletón y doble paletón (BIT-E) llaves Abloy (ABL-E) y Ford (FD-E).

Special machine for Regata keys. In addition, this machine has optional carriages for BIT keys (BIT-E), Abloy Keys (ABL-E) and Ford (FD-E).

## ECCO FORD



Máquina semiautomática para llaves de gorja de tipo regata. Máquina especial para el duplicado a código de llaves FO-6.P. Además, esta máquina dispone de carros opcionales para el duplicado de llaves de gorja (BIT-E), Abloy (ABL-E) y Regata (RG-E).

A Machine specifically designed for the duplication of Ford FO-6.P keys to code. In addition, this machine has optional carriages for BIT keys (BIT-E), Abloy (ABL-E) and Race (RG-E).

## ECCOABLOY



Máquina especial para el duplicado de llaves denominadas tipo Abloy. Además, esta máquina dispone de carros opcionales para el duplicado de llaves de gorja (BIT-E), Ford (FD-E) y Regata (RG-E).

Special machine for Abloy Keys. In addition, this machine has optional carriages for BIT keys (BIT-E), Ford (FD-E) and Regata (RG-E).



## FRESAS CUTTERS

CODE	AXBXC	Cor. Lateral Side Cut	PALP.	PARA-FOR	MAT
FP-7	63x1,25x16	X	PP-7	ECCO BIT-DETROIT	HSS
FP-8	63x1,4x16	X	PP-8	ECCO BIT-DETROIT	HSS
FP-9	63x1x16		PP-9	ECCO BIT	HSS
FP-10	63x2,4x16		PP-10	ECCO FORD-ECCO ABLOY-PASADENA-NEBRASCA	HSS
FP-17	80x1,25x16	X		SARATOGA-YAKARTA-TITAN BIT	HSS
FP-18	80x1,25x22	X		ATLANTA-TOPEKA	HSS
FP-19	80x1,4x16	X		SARATOGA-YAKARTA-TITAN BIT-DAKOTA G	HSS
FP-20	80x1,4x22	X		ATLANTA-TOPEKA	HSS
FP-21	80x1,5x22	X		DUPLEX-ATLANTA-TOPEKA-KANSAS	HSS
FP-21W	80x1,5x22	X		DUPLEX-ATLANTA-TOPEKA-KANSAS	W
FP-22	80x1x16			SARATOGA-DAKOTA G-TITAN BIT	HSS
FP-23	80x1x22	X		DUPLEX-ATLANTA-TOPEKA	HSS
FP-26	80x1,5x16			SARATOGA-YAKARTA-DAKOTA-G-SENNA	HSS
FP-26W	80x1,5x16			SARATOGA-YAKARTA-DAKOTA-G-SENNA	W
FP-27W	70x2,4x16			AVANTCODE	W
FP-28W	70x1,7x16			AVANTCODE	W
FP-31	80x1,6x16			SARATOGA-DAKOTA G-TITAN BIT	HSS
FP-33W	70x1,25x16			AVANTCODE	W

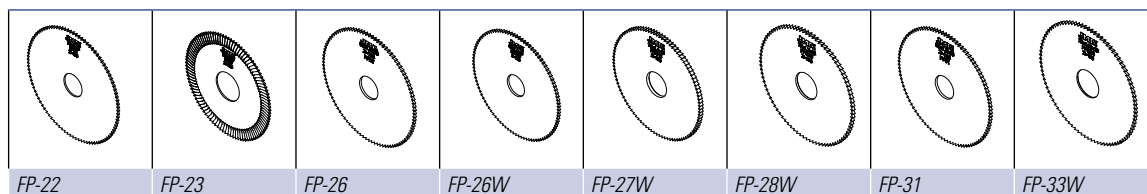
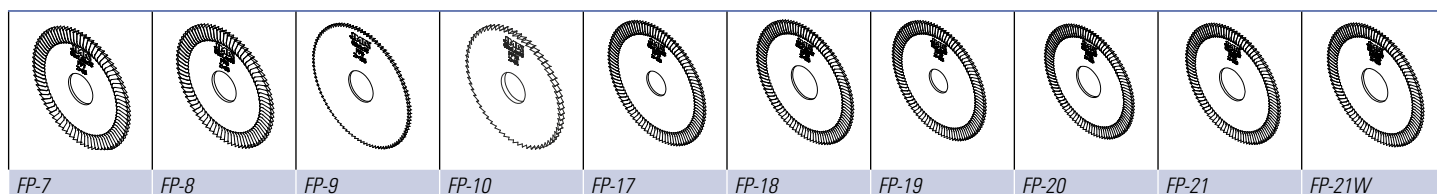
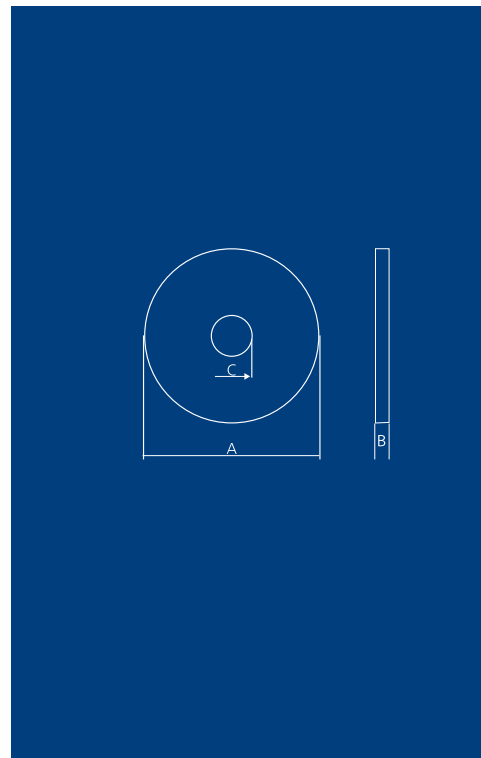

## SIMBOLOGÍA SYMBOLS

W

**Fresa de metal duro**  
Metal gogoroko fresa  
Hard metal cutters  
Fraise en métal dur  
Fräsen für Hartmetall



**Espesor**  
Lodiera  
Thickness  
Épaisseur  
Stärke



**Diámetro interior**  
Barnealdeko diametroa  
Internal diameter  
Alésage  
Innen-Durchmesser

HSS

**Acero extra rápido**  
Altzairu estrea azkarra  
High-speed steel  
Acier extra rapide  
Extraschneller Stahl



**Diámetro externo**  
Kanpoaldeko diametroa  
External diameter  
Diamètre extérieur  
Aussen-Durchmesser



## PALPADORES TRACERS

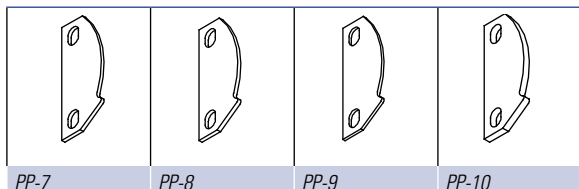

PP-7

PP-8

PP-9

PP-10



## ADAPTADORES ADAPTORS

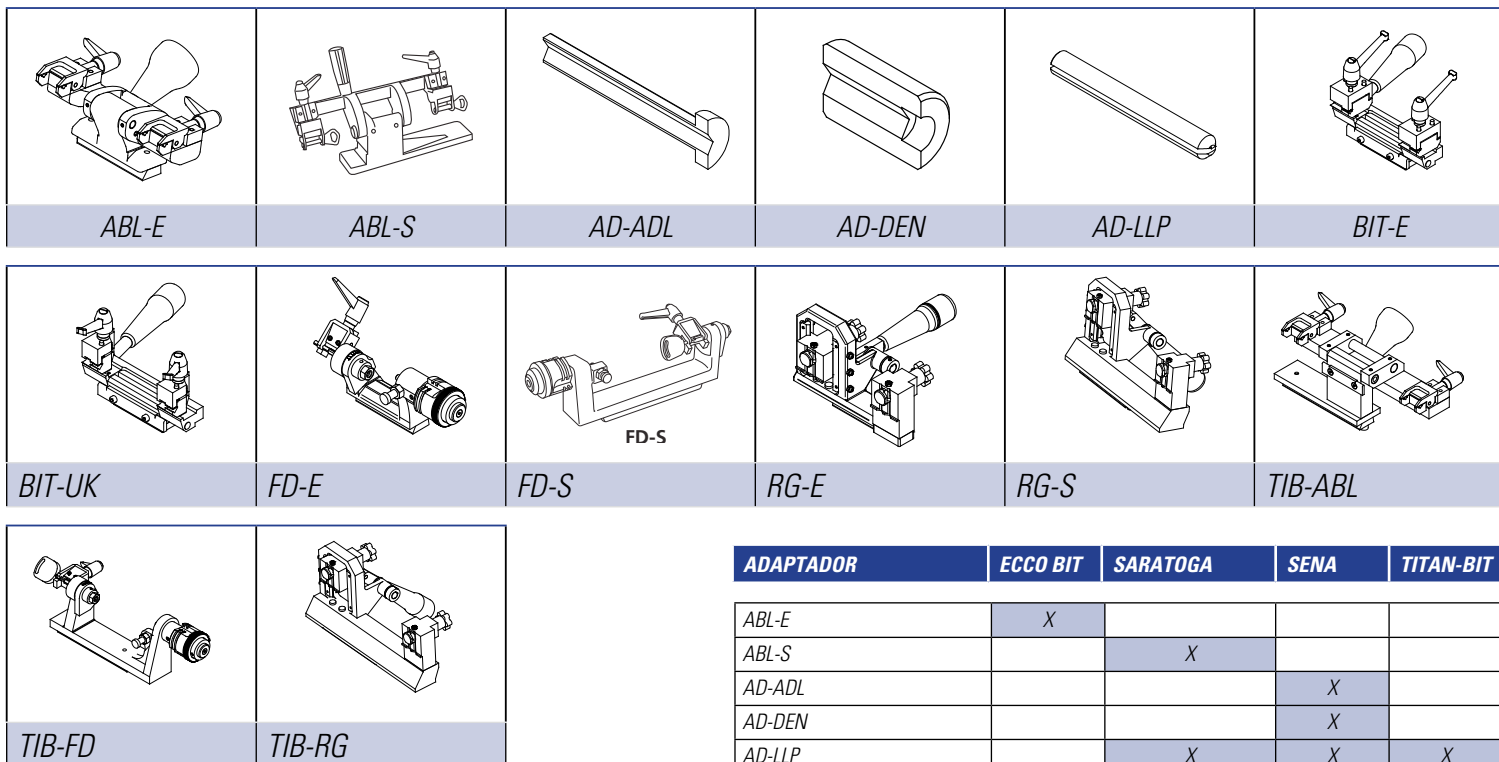

ADAPTADOR	ECCO BIT	SARATOGA	SENA	TITAN-BIT
ABL-E	X			
ABL-S		X		
AD-ADL			X	
AD-DEN			X	
AD-LLP		X	X	X
BIT-E	X			
BIT-UK	X			
FD-E	X			
FD-S		X		
RG-E	X			
RG-S		X		
TIB-ABL				X
TIB-FD				X
TIB-RG				X



**MÁQUINA PARA LLAVES GORJA**  
GORJA-GILTZETARAKO MAKINAK  
MACHINES FOR BIT KEYS  
MACHINES POUR CLES A GORGES  
MASCHINEN FÜR DOPPELBARTSCHLÜSSEL

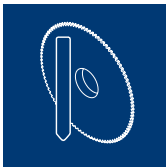

**FRESAS**  
FRESAK  
CUTTERS  
FRAISES  
FRÄSEN



**PALPADORES**  
HAZTAGAILUAK  
TRACERS  
PALPEURS  
FÜHLER



**ACCESORIOS**  
OSAGARRIAK  
ACCESSORIES  
ADAPTATEURS  
ZUBEHÖR

**SARATOGA****SARATOGA****SENA****SENA****EBIT****ECCO BIT****EABLOY****ECCO ABLY****EFORD****ECCO FORD****EFORD****ECCO REGATA****TITAN BIT****TITAN BIT**



# **FICHA ESPECIALISTA**

ESPEZIALISTAREN FITXA

SPECIALIST FILE

FICHE SPÉCIALISÉE

DATENBLATT FÜR FACHLEUTE

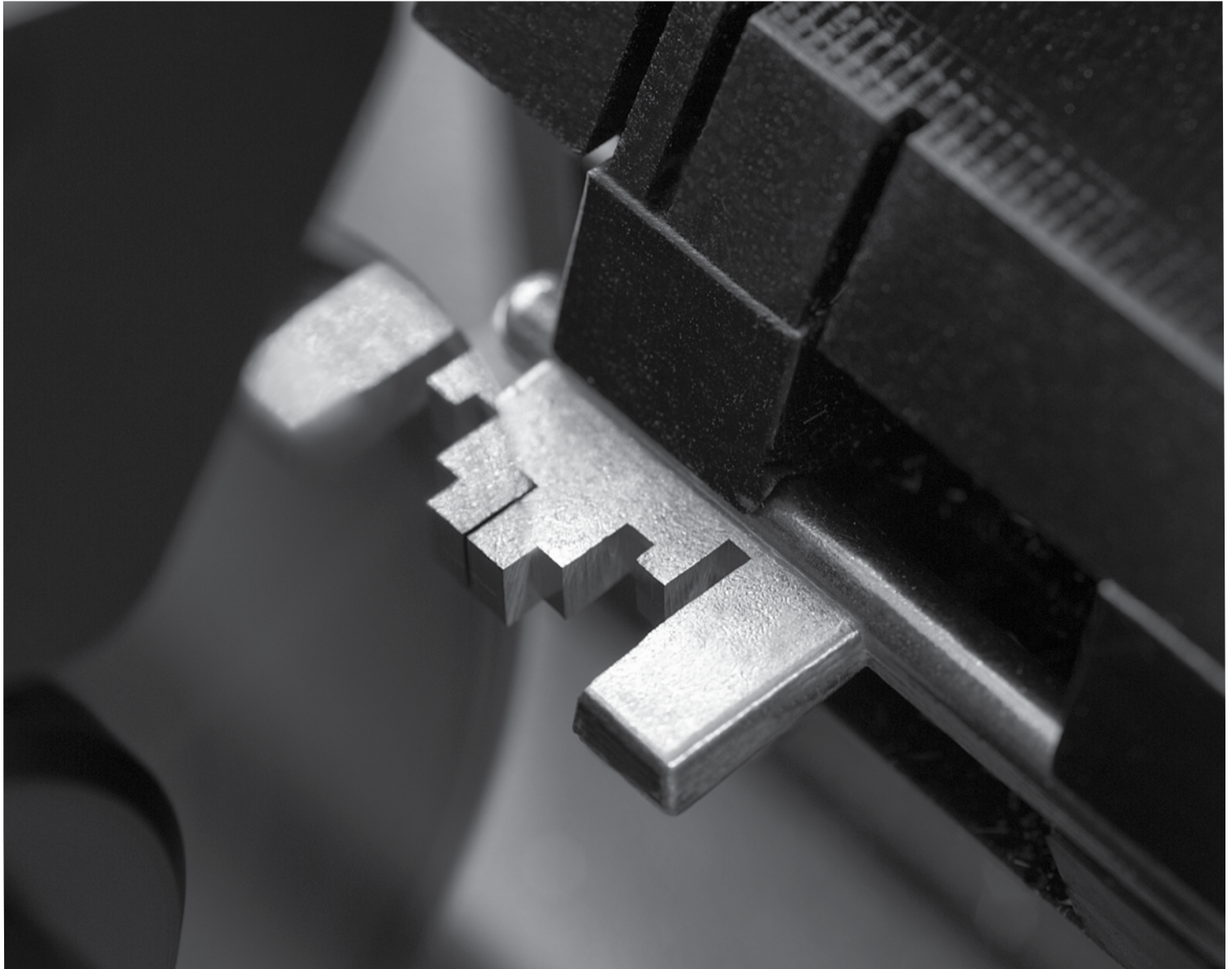

**SENA - SARATOGA - TITAN BIT**  
**ECCOBIT - ECCORG - ECCOFORD - ECCOABLOY**

## **PARA LLAVES DE GORJA**

GILTZA LAUETARAKO





FOR BIT KEYS





POUR CLES À GORGES

FÜR DOPPELBARTSCHLÜSSEL

**THE KEY TO EXCELLENCE**







GLOBALLY UNLOCKING MILLIONS OF DOORS DAILY

®	JMA				
<b>ABLOY</b>	ABL-1	SARATOGA			ABL-S
		TITANBIT			TIB-ABL
		EABLOY			ABL-E
	ABL-2	SARATOGA			ABL-S
		TITANBIT			TIB-ABL
		EABLOY			ABL-E
	ABL-3	SARATOGA			ABL-S
		TITANBIT			TIB-ABL
		EABLOY			ABL-E
	ABL-4	SARATOGA			ABL-S
		TITANBIT			TIB-ABL
		EABLOY			ABL-E
<b>ABUS</b>	ABU-29P	SARATOGA			ABL-S
		TITANBIT			TIB-ABL
		EABLOY			ABL-E
	ABU-3	SARATOGA			ABL-S
		TITANBIT			TIB-ABL
		EABLOY			ABL-E
<b>ADPLE</b>	ADPLE-11	SENA			AD-ADL
	ADPLE-22	SENA			AD-ADL
	ADPLE-33	SENA			AD-ADL
	ADPLE-44	SENA			AD-ADL
	ADPLE-55	SENA			AD-ADL
<b>ANCHOR</b>	ANC-2	SARATOGA			ABL-S
		TITANBIT			TIB-ABL
		EABLOY			ABL-E

®	JMA					
<b>ARCU</b>	ARC-17DP	SENA			AD-LLP	
		SARATOGA			AD-LLP	
		TITANBIT			AD-LLP	
		EBIT			BIT-E	
	ARC-17P	SENA			AD-LLP	
		SARATOGA			AD-LLP	
<b>ARFE</b>	ARFE-2	SENA			AD-LLP	
		SARATOGA			AD-LLP	
		TITANBIT			AD-LLP	
		EBIT			BIT-E	
<b>DENNY</b>	DEN-1	SENA			AD-DEN	
	DEN-2	SENA			AD-DEN	
<b>DIEBOLD</b>	DIE-1	SENA			AD-LLP	
		EBIT			BIT-E	
<b>FORD</b>	FO-22P	SARATOGA				
		EBIT			BIT-UK	
	FO-4P	SARATOGA				
		EBIT			BIT-UK	
FO-6P	SARATOGA				FD-S	
	TITANBIT				TIB-FD	
	EFORD				FD-E	
<b>HECTOR</b>	HEC-1	SENA			AD-LLP	
		SARATOGA			AD-LLP	



					
<b>HECTOR</b>		TITANBIT			AD-LLP
		EBIT			BIT-E
<b>IFAM</b>	IF-3P	SARATOGA			ABL-S
		TITANBIT			TIB-ABL
		EABLOY			ABL-E
	MILES	MIL-1	SENA		
		SARATOGA			AD-LLP
<b>MILES</b>	MIL-1	TITANBIT			AD-LLP
		EBIT			BIT-E
	MIL-2	SENA			AD-LLP
		SARATOGA			AD-LLP
		TITANBIT			AD-LLP
		EBIT			BIT-E
<b>PENZ-MASH</b>	PEN-2	SENA			AD-LLP
		SARATOGA			AD-LLP
		TITANBIT			AD-LLP
		EBIT			BIT-E
<b>RIL</b>	26-M	SENA			AD-LLP
		SARATOGA			AD-LLP
		TITANBIT			AD-LLP
		EBIT			BIT-E
<b>SERRETA</b>	7-S	SENA			AD-LLP
		SARATOGA			AD-LLP
		TITANBIT			AD-LLP
		EBIT			BIT-E

					
<b>SOLER</b>	SOL-1	SENA			AD-LLP
		SARATOGA			AD-LLP
		TITANBIT			AD-LLP
		EBIT			BIT-E
<b>TIBBE</b>	JAU-1P	SARATOGA			FD-S
		TITANBIT			TIB-FD
		EFORD			FD-E
		JAU-2P	SARATOGA		
		TITANBIT			TIB-FD
		EFORD			FD-E
<b>TRUPER</b>	TRU-7	SARATOGA			ABL-S
		TITANBIT			TIB-ABL
		EABLOY			ABL-E
		TRU-8P	SARATOGA		
		TITANBIT			TIB-ABL
		EABLOY			ABL-E
<b>URKO</b>	URKO-4	SENA			AD-LLP
		SARATOGA			AD-LLP
		TITANBIT			AD-LLP
		EBIT			BIT-E
<b>YALE</b>	YA-30	SENA			AD-LLP
		SARATOGA			AD-LLP
		TITANBIT			AD-LLP
		EBIT			BIT-E









## JMA HEADQUARTERS

### JMA ALEJANDRO ALTUNA, S.L.U.

Tel +34 943 79 30 00  
Fax +34 943 79 72 43  
Bidekurritza, 6  
P.O.Box - Apdo. 70  
20500 Arrasate - Mondragón  
Gipuzkoa - SPAIN

www.jma.es  
ventas@jma.es

## JMA ARGENTINA

JMA ARGENTINA S.A.  
Tel +54 336 4 462 422  
Fax +54 336 4 462 422  
Av. Central Acero Argentino Oeste 678  
Parque industrial COMIRSA  
2900 San Nicolas (Prov. Buenos Aires)

www.jma-argentina.com.ar  
info@jma-argentina.com.ar

## JMA FRANCE

Tel +33 01 39 22 42 10  
Fax +33 01 39 22 42 11  
Technoparc  
13, rue Edouard Jeanneret  
F-78306 Poissy Cedex

www.jmafrance.fr  
service.commercial@jmafrance.fr

## JMA INDIA

JMA KEYS INDIA PVT. LTD  
Tel +91 124 428 5450  
Fax +91 124 428 5451  
H-239 & H-240, Sushant Shopping Arcade  
122002 Gurgaon  
Haryana

www.jmakeys.in  
info@jmakeys.in

## JMA MAROC

JMA MAROC S.A.R.L.  
Tel +0520 150 535  
Fax +0520 150 536  
83,85 Bd Oued ZIZ, El Oulfa

Casablanca  
Marruecos

www.jma.ma  
jma@jma.ma

## JMA MEXICO

LLAVES ALTUNA DE MEXICO S.A de C.V  
Tel +52 33 3777 1800  
Fax +52 33 3777 1809  
Av. Aviación No. 5520  
Col. San Juan de Ocotán  
C.P. 45019 Zapopan, Jalisco

www.jma.com.mx  
ventas@jma.com.mx

## JMA PERÚ

JMA Perú S.A.C.  
Tel +51 639 9300  
Av. Los Paracas 130, Urbanización Salamanca,  
Distrito Ate, Lima

www.jma-peru.com  
info@jma-peru.com

## JMA POLSKA

JMA POLSKA Sp. z o.o.  
Tel +48 42 635 12 80  
Fax +48 42 635 12 85  
91-342 Łódź, ul. Zbąszyńska 3

www.jmapolska.pl  
biuro@jmapolska.pl

## JMA PORTUGAL

ALTUNA PORTUGAL  
COMERCIO DE CHAVES UNIPESSOAL, LDA.  
Tel +351 219 947 470  
Fax +351 219 947 471  
Rua de Goa, N.º 22  
2690-356 Santa Ina de Azóia LOURES(Lisboa)

www.jmaportugal.com  
comercial@jmaportugal.com

## JMA UK

SKS LTD  
Tel +44 144 229 1400  
Fax +44 144 286 3683  
Unit 2, Canalside  
Northbridge Road  
Berkhamsted  
Herts HP4 1EG

www.jmakeys.co.uk  
sales@skskkeys.co.uk

## JMA URUGUAY

JMA URUGUAY S.A.  
Tel +598 2908 1175  
Fax +598 2900 6681  
Mercedes 1420  
11100 Montevideo  
Uruguay

www.jma.com.uy  
info@jma.com.uy

## JMA USA

ALTUNA GROUP USA INC.  
Tel +1 817 385 0515  
Fax +1 817 385 4850  
1513 Greenview Drive  
75050 Grand Prairie, Texas

www.jmausa.com  
info@jmausa.com